

41

MattoniBricks



**Rivestimenti Naturali**  
*Natural Coverings*





## Rivestimenti Naturali

Capolavori della natura e dell'uomo. Per gli interni e gli esterni, materiali resistenti per natura, irresistibili per bellezza. Ci vuole un nuovo equilibrio tra l'architettura, l'edilizia e il pianeta. Per questo B&B propone una collezione di rivestimenti fatti esclusivamente di materiali naturali e nobili, sono la "pelle" della casa, capaci di dare calore a ogni ambiente, e di conservare la loro bellezza nel tempo. Pareti, facciate, tetti e pavimentazioni: ogni superficie trova un'armonia tutta naturale, grazie a materiali che si distinguono a prima vista, e che si apprezzano a lunga durata.

## *Natural Coverings*

*Masterpieces by nature and man. For indoors and outdoors, these materials are resistant by nature and irresistibly beautiful. We need a new balance between architecture, building and the earth. This is why B&B has launched a collection of coverings that are made exclusively from natural and noble materials; they are the "skin" of the home and can infuse every kind of environment with warmth, while maintaining their beauty over time. Walls, facings, roofings and pavings: each different surface reaches a perfect harmony with its surroundings, thanks to materials that can be noticed at first glance and that are appreciated in the long term.*



Genesis

22

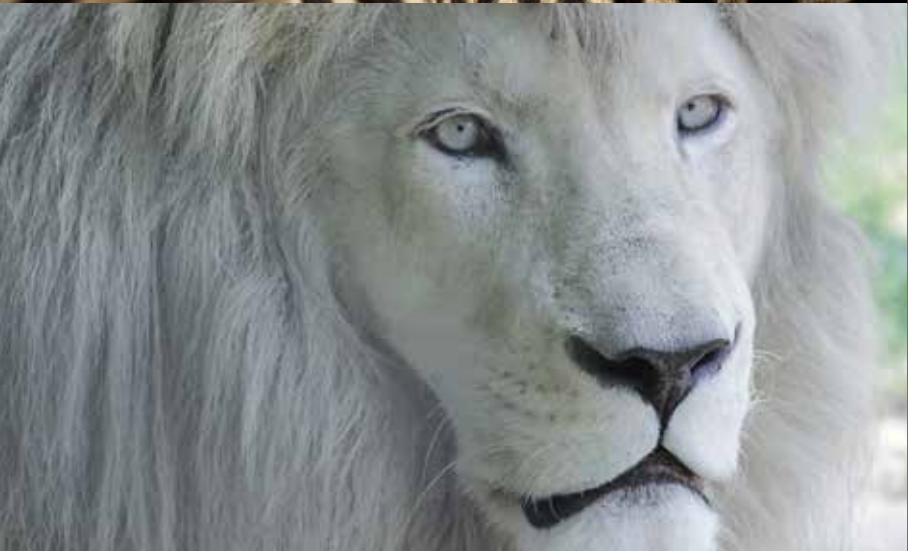

Grande Réserve

146



Futura

188





212

Croma



290

Fortis



304

Cotto



# Rivestimenti *Facings*



## Genesis

**Mattoni e Listelli faccia a vista**  
*Facing Bricks and Brick-slips*

	p.
Genesis 002	90
Genesis 150	26
Genesis 190	124
Genesis 200	52
Genesis 215	40
Genesis 220	126
Genesis 240	130
Genesis 250	94
Genesis 260	92
Genesis 270	132
Genesis 280	54
Genesis 300	74
Genesis 320	114
Genesis 340	80
Genesis 390	112
Genesis 415	32
Genesis 420	48
Genesis 440	128
Genesis 450	120
Genesis 490	98
Genesis 500	100
Genesis 510	56
Genesis 520	60
Genesis 550	118
Genesis 600	108
Genesis 620	62
Genesis 630	66
Genesis 660	134
Genesis 700	122
Genesis Alfa	84
Genesis E80	138
Genesis E90	140
Genesis L10	142
Genesis L12	144



## Grande Réserve

**Mattoni e Listelli faccia a vista**  
*Facing Bricks and Brick-slips*

	p.
Grande Réserve 5	152
Grande Réserve 7	158
Grande Réserve E20	166
Grande Réserve E22	168
Grande Réserve T50	160
Grande Réserve T52	162
Grande Réserve W40	170
Grande Réserve W41	174
Grande Réserve W42	176
Grande Réserve W43	180
Grande Réserve W44	182
Grande Réserve W45	184



## Futura

**Listelli faccia a vista**  
*Facing Brick-slips*

	p.
Futura 226	192
Futura 382	202
Futura 505	208
Futura 507	210
Futura 737	200
Futura 747	203
Futura 757	194
Futura 764	196
Futura 943	204
Futura 945	206
Futura 985	193
Futura 991	198



## Croma

### Mattoni e Listelli smaltati

*Glazed bricks and brick-slips*

p. 212

Croma 11	218
Croma 12	220
Croma 13	222
Croma 14	224
Croma 15	226
Croma 21	228
Croma 22	230
Croma 23	232
Croma 24	234
Croma 25	236
Croma 31	238
Croma 32	244
Croma 33	250
Croma 41	256
Croma 42	258
Croma 71	262
Croma 72	264
Croma 73	268
Croma 74	270
Croma 75	274
Croma 91	278
Croma 92	279
Croma 93	280

## Pavimentazioni *Pavings*

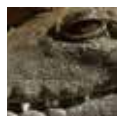

## Fortis

### Mattoni per pavimentazione

*Paving Bricks*

p. 290

Fortis 717	294
Fortis 727	296
Fortis 747	298
Fortis 767	300
Fortis 777	302



## Cotto

### Antico cotto fatto a mano

*Antique handmade terracotta*

p. 304

Formati • Sizes	306
-----------------	-----

## Extra *Extra*

### DrySystem

p. 316

### Stucco e colla

*Stucco and glue*

320

### Istruzioni di posa listelli

*Brick-slips application instructions*

322



www.bb-sas.it

## Cartella colori • *Colour range*

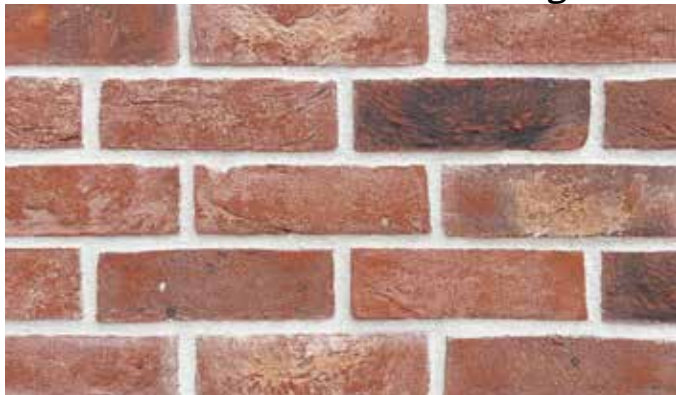

**Genesis 150**

pag. 26

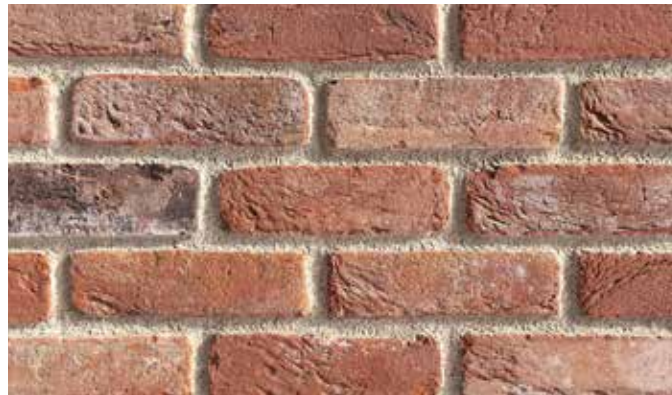

**Genesis 415**

pag. 32



**Genesis 215**

pag. 40



**Genesis 420**

pag. 48



**Genesis 200**

pag. 52



**Genesis 280**

pag. 54



# Genesis



**Genesis 510**

pag. 56



**Genesis 520**

pag. 60



**Genesis 620**

pag. 62

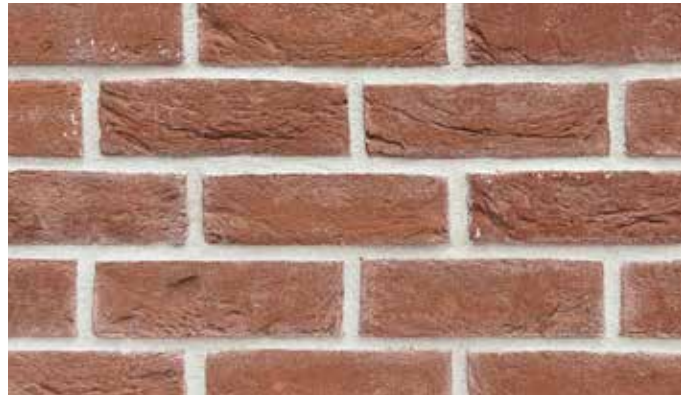

**Genesis 630**

pag. 66



**Genesis 300**

pag. 74



**Genesis 340**

pag. 80

Cartella colori • *Colour range*



**Genesis Alfa**

pag. 84



**Genesis 002**

pag. 90



**Genesis 260**

pag. 92



**Genesis 250**

pag. 94

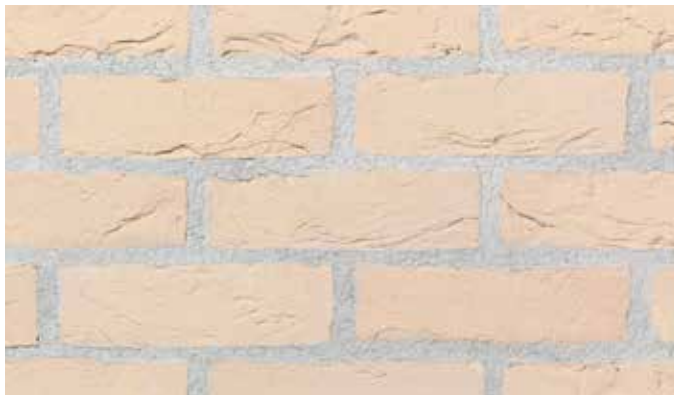

**Genesis 490**

pag. 98



**Genesis 500**

pag. 100

# Genesis



**Genesis 600**

pag. 108



**Genesis 390**

pag. 112

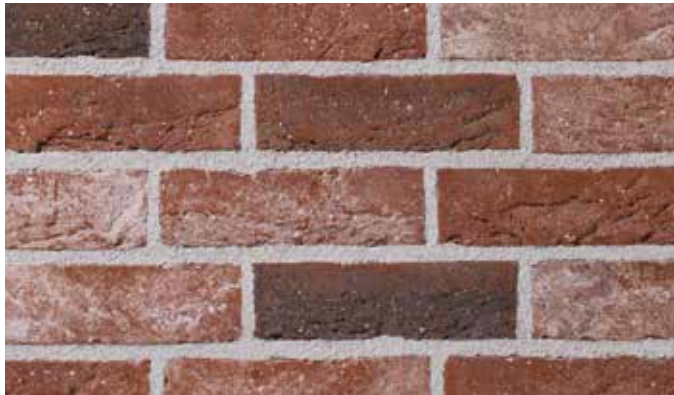

**Genesis 320**

pag. 114



**Genesis 550**

pag. 118



**Genesis 450**

pag. 120



**Genesis 700**

pag. 122

Cartella colori • *Colour range*

Genesis



**Genesis 190**

pag. 124



**Genesis 220**

pag. 126



**Genesis 440**

pag. 128



**Genesis 240**

pag. 130



**Genesis 270**

pag. 132



**Genesis 660**

pag. 134

# Genesis

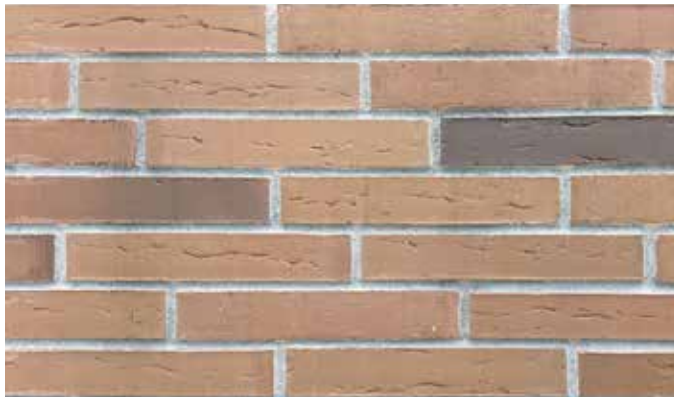

**Genesis E80**

pag. 138



**Genesis E90**

pag. 140



**Genesis L10**

pag. 142



**Genesis L12**

pag. 144

# Grande Réserve

Cartella colori • *Colour range*





**Grande Réserve W40**

pag. 170



**Grande Réserve W41**

pag. 174



**Grande Réserve W42**

pag. 176



**Grande Réserve W43**

pag. 180



**Grande Réserve W44**

pag. 182



**Grande Réserve W45**

pag. 184

## Cartella colori • *Colour range*

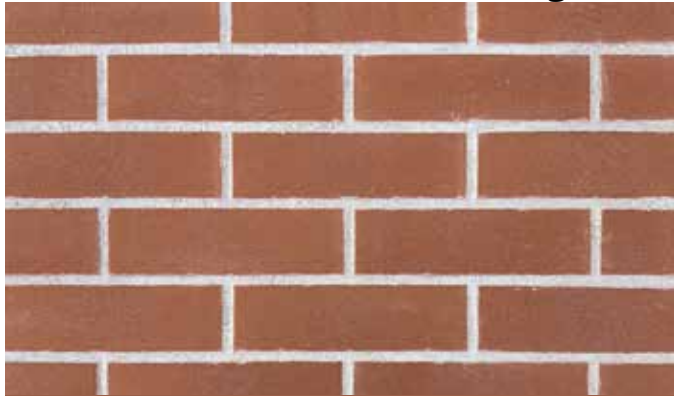

**Futura 226**

pag. 192



**Futura 985**

pag. 193



**Futura 757**

pag. 194



**Futura 764**

pag. 196



**Futura 991**

pag. 198



**Futura 737**

pag. 200



# Futura



**Futura 382**

pag. 202



**Futura 747**

pag. 203



**Futura 943**

pag. 204



**Futura 945**

pag. 206

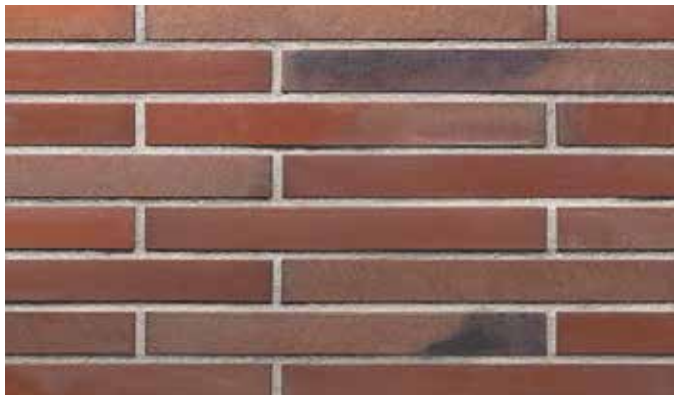

**Futura 505**

pag. 208



**Futura 507**

pag. 210

## Cartella colori • *Colour range*

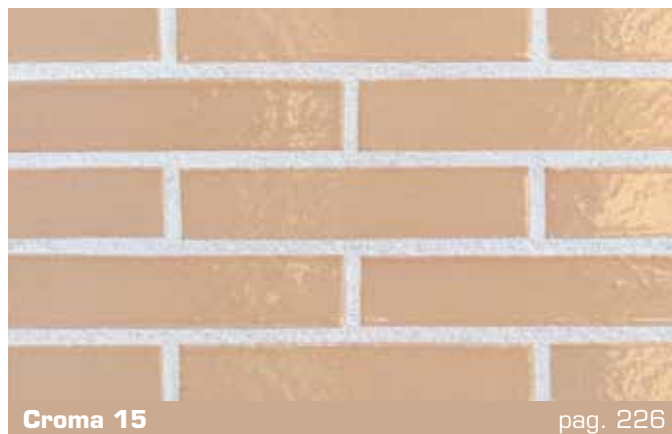
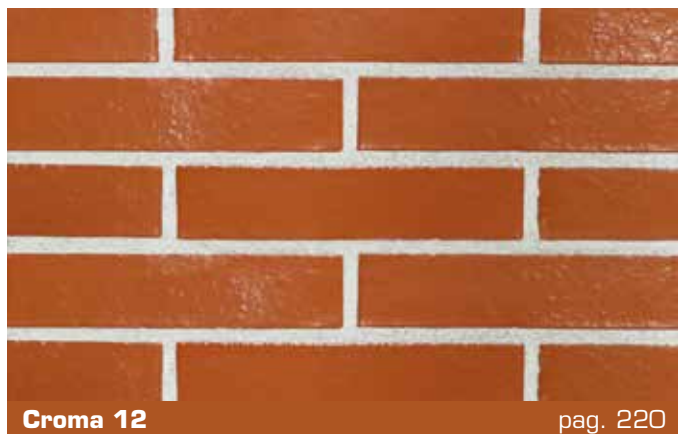
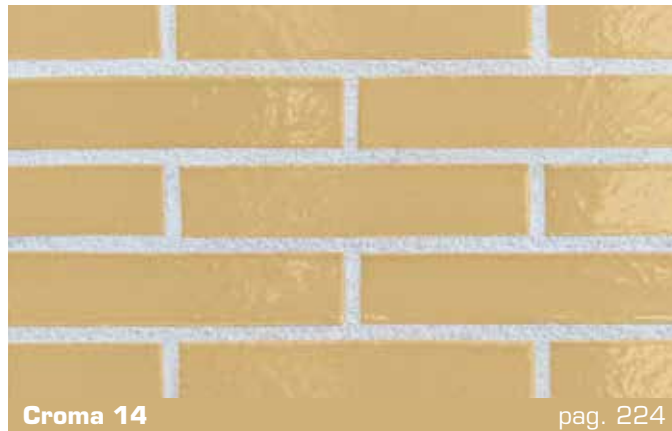
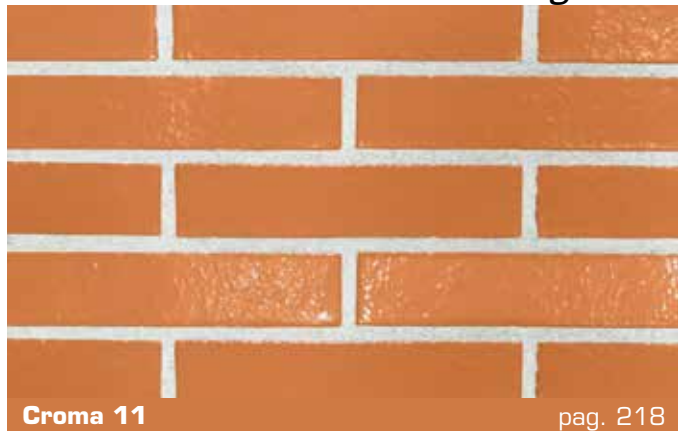

# Croma

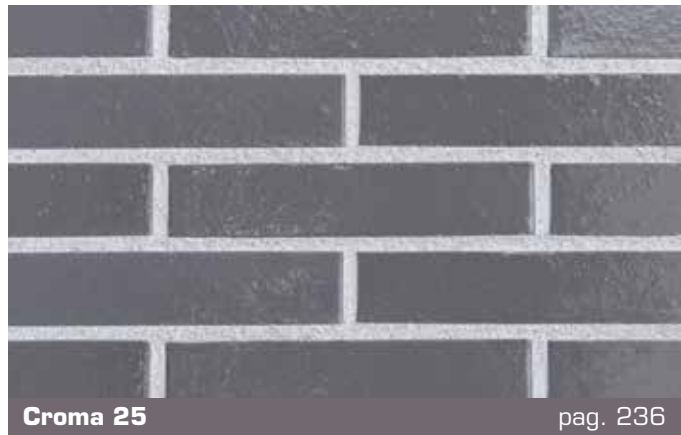
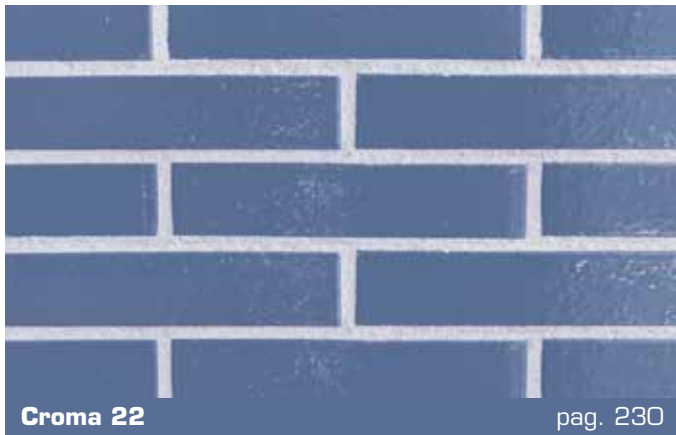
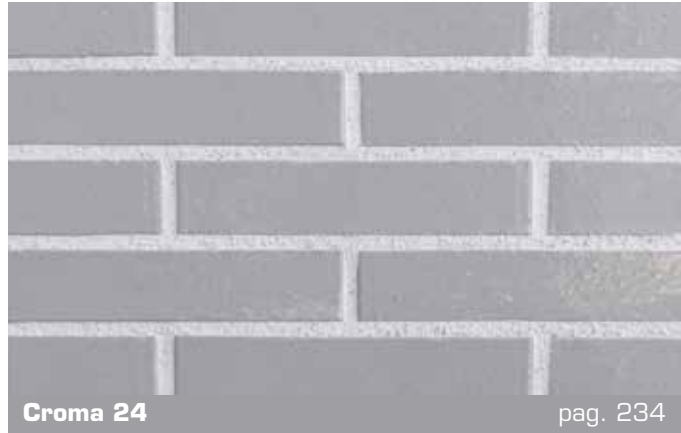
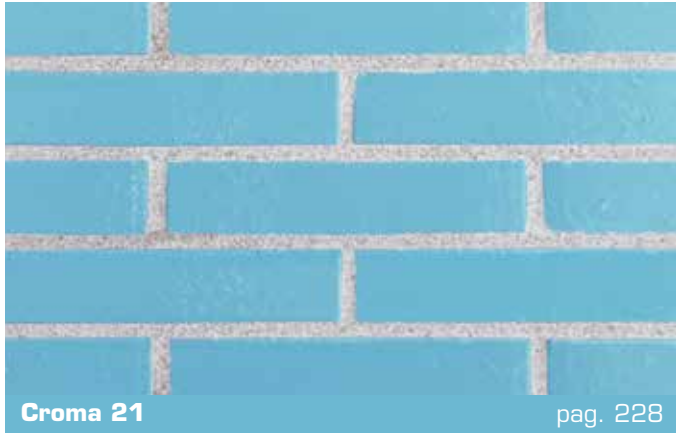

Cartella colori • *Colour range*

**Croma**

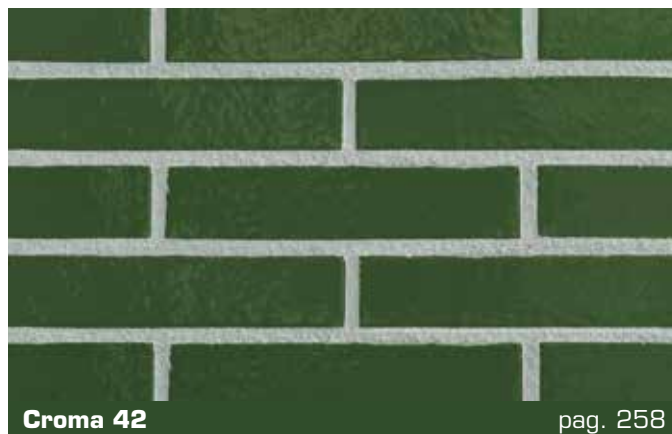
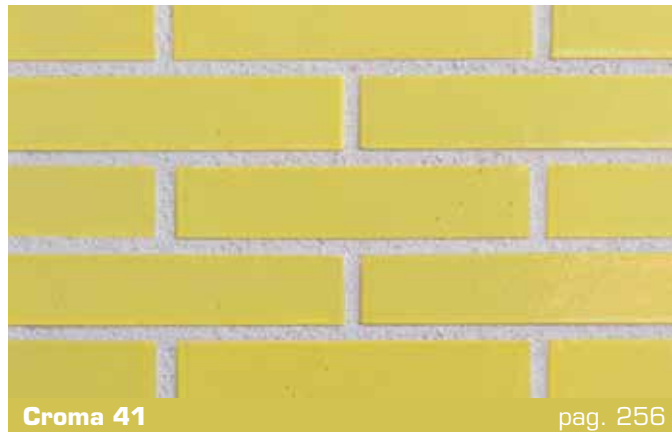

# Croma



**Croma 71**

pag. 262



**Croma 74**

pag. 270



**Croma 72**

pag. 264



**Croma 75**

pag. 274



**Croma 73**

pag. 268

## Cartella colori • *Colour range*

**Croma**



**Croma 91**

pag. 278



**Croma 92**

pag. 279



**Croma 93**

pag. 280

La serie Croma 91-92-93  
è realizzata con colori metallizzati

*Croma 91-92-93 series  
is realized in metallic colours*









Rivestimenti Naturali

Genesis

## Mattoni e listelli faccia a vista

### **Una vista memorabile**

È un materiale in cui la semplicità viene elevata a meraviglia. Ogni mattone nasce dalla ricerca tecnologica di nuove soluzioni tecniche ed estetiche e dalla riscoperta di colori e finiture che appartengono alla storia più bella dell'architettura. Il risultato è una collezione ricchissima nella varietà dei colori e delle texture, nei formati e nella scelta tra mattoni o listelli fatti a mano, anticati ed estrusi, ideali per trasformare e aggiungere bellezza alle pareti esterne o interne della casa. Si tratta di mattoni di elevata qualità ad alte prestazioni: resistenti al gelo, ineflorescenti, di elevata inerzia termica. È l'idea giusta per dare più pregio alla tua casa.

### *Facing bricks and brick-slips*

#### **A memorable sight**

*The simple features of this material are enhanced in a wonderful way. Each brick comes from the technological research into new technical and aesthetical solutions. The source of inspiration are the colours and finishing touches of the finest architectural periods. The end result is a very extensive collection that includes a variety of colours, textures and shapes. You can choose between handmade, antique or extruded facing bricks and brick-slips. They are ideal to transform and enhance the beauty of both internal and external walls of your home. These high quality bricks have brilliant performances: they are frost resistant and they are not blooming; they have an excellent thermal inertia. That's the ideal way to make the best out of your home.*





Mattoni di elevata qualità,  
fatti a mano, anticati ed estrusi,  
tutti disponibili nei formati pieno,  
listello e angolare.

*Bricks that are high quality,  
handmade, antique and extruded;  
they are all available as full bricks,  
brick-slips and corners.*

# Genesis 150

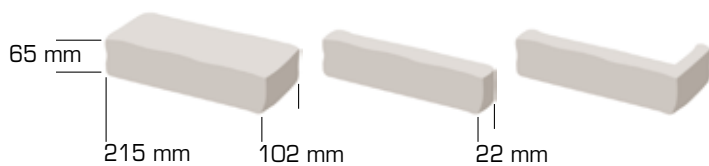

peso mattone • <i>brick weight</i>	± 2,1 Kg
peso listello • <i>brick-slip weight</i>	± 0,45 Kg
pezzi a mq • <i>pieces x sqm</i>	± 58 pcs/m <sup>2</sup>
mattoni per bancale • <i>bricks x pallet</i>	680
listelli per scatola • <i>brick-slips x box</i>	30
listelli per bancale • <i>brick-slips x pallet</i>	1680
angolari per scatola • <i>corners x box</i>	16
angolari per bancale • <i>corners x pallet</i>	1024







Genesis 150







# Genesis 415

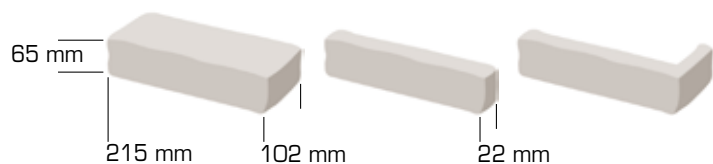

peso mattone • <i>brick weight</i>	± 2,2 Kg
peso listello • <i>brick-slip weight</i>	± 0,50 Kg
pezzi a mq • <i>pieces x sqm</i>	± 58 pcs/m <sup>2</sup>
mattoni per bancale • <i>bricks x pallet</i>	600
listelli per scatola • <i>brick-slips x box</i>	30
listelli per bancale • <i>brick-slips x pallet</i>	1.680
angolari per scatola • <i>corners x box</i>	16
angolari per bancale • <i>corners x pallet</i>	1.024



I mattoni pieni Genesis 415 sono sottoposti ad un'alterazione superficiale, in modo da ottenere l'aspetto di un mattone di recupero; presentano residui di malta e spigoli arrotondati, che li fanno apparire come se fossero stati esposti alle intemperie per molti anni, alla demolizione ed alla pulizia.

*The full Genesis 415 bricks undergo a process of surface alteration that gives them the appearance of old used bricks. The surface mortar residues and rounded edges make them look as if they were exposed to bad weather for many years, then demolished and cleaned.*

Genesis 4:15









Genesis 4:15







# Genesis 215

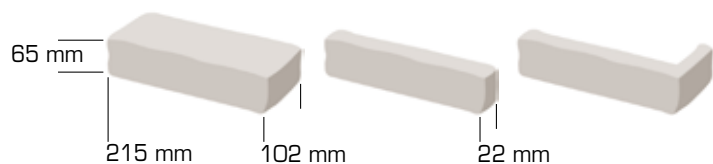

peso mattone • <i>brick weight</i>	± 2,1 Kg
peso listello • <i>brick-slip weight</i>	± 0,45 Kg
pezzi a mq • <i>pieces x sqm</i>	± 58 pcs/m <sup>2</sup>
mattoni per bancale • <i>bricks x pallet</i>	600
listelli per scatola • <i>brick-slips x box</i>	30
listelli per bancale • <i>brick-slips x pallet</i>	1.680
angolari per scatola • <i>corners x box</i>	16
angolari per bancale • <i>corners x pallet</i>	1.024



I mattoni pieni Genesis 215 sono sottoposti ad un'alterazione superficiale, in modo da ottenere l'aspetto di un mattone di recupero, presentano residui di malta e spigoli arrotondati, che li fanno apparire come se fossero stati esposti alle intemperie per molti anni, alla demolizione ed alla pulizia.

*The surface of the full Genesis 215 bricks undergoes a process that gives them the appearance of old used bricks. The surface mortar residues and rounded edges make them look as if they were exposed to bad weather for many years, then demolished and cleaned.*















# Genesis 420

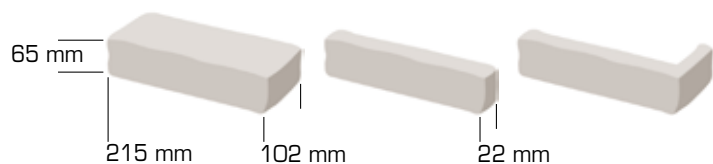

peso mattone • <i>brick weight</i>	± 2,1 Kg
peso listello • <i>brick-slip weight</i>	± 0,45 Kg
pezzi a mq • <i>pieces x sqm</i>	± 58 pcs/m <sup>2</sup>
mattoni per bancale • <i>bricks x pallet</i>	600
listelli per scatola • <i>brick-slips x box</i>	30
listelli per bancale • <i>brick-slips x pallet</i>	1.680
angolari per scatola • <i>corners x box</i>	16
angolari per bancale • <i>corners x pallet</i>	1.024







# Genesis 200

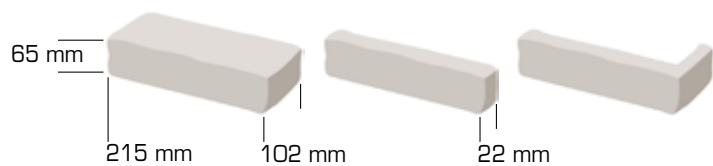

peso mattone • <i>brick weight</i>	± 2,1 Kg
peso listello • <i>brick-slip weight</i>	± 0,45 Kg
pezzi a mq • <i>pieces x sqm</i>	± 58 pcs/m <sup>2</sup>
mattoni per bancale • <i>bricks x pallet</i>	628
listelli per scatola • <i>brick-slips x box</i>	30
listelli per bancale • <i>brick-slips x pallet</i>	1680
angolari per scatola • <i>corners x box</i>	16
angolari per bancale • <i>corners x pallet</i>	1024



# Genesis 280

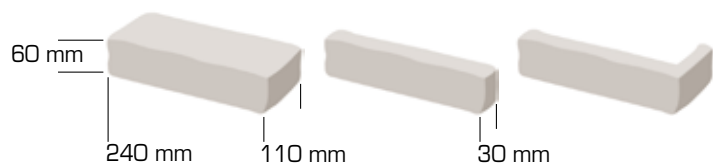

peso mattone • <i>brick weight</i>	± 2,8 Kg
peso listello • <i>brick-slip weight</i>	± 0,55 Kg
pezzi a mq • <i>pieces x sqm</i>	± 58 pcs/m <sup>2</sup>
mattoni per bancale • <i>bricks x pallet</i>	267
listelli per scatola • <i>brick-slips x box</i>	34
listelli per bancale • <i>brick-slips x pallet</i>	1428
angolari per scatola • <i>corners x box</i>	20
angolari per bancale • <i>corners x pallet</i>	840





# Genesis 510

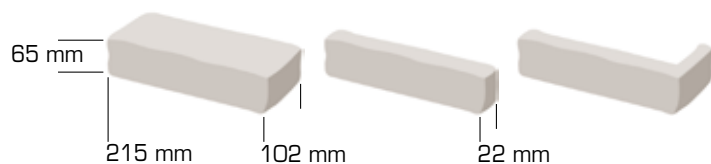

peso mattone • <i>brick weight</i>	± 2,1 Kg
peso listello • <i>brick-slip weight</i>	± 0,45 Kg
pezzi a mq • <i>pieces x sqm</i>	± 58 pcs/m <sup>2</sup>
mattoni per bancale • <i>bricks x pallet</i>	680
listelli per scatola • <i>brick-slips x box</i>	30
listelli per bancale • <i>brick-slips x pallet</i>	1680
angolari per scatola • <i>corners x box</i>	16
angolari per bancale • <i>corners x pallet</i>	1024



Genesis 510





# Genesis 520

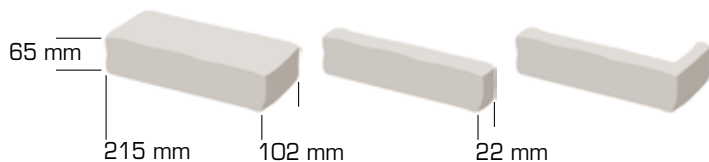

peso mattone • <i>brick weight</i>	± 2,1 Kg
peso listello • <i>brick-slip weight</i>	± 0,45 Kg
pezzi a mq • <i>pieces x sqm</i>	± 58 pcs/m <sup>2</sup>
mattoni per bancale • <i>bricks x pallet</i>	660
listelli per scatola • <i>brick-slips x box</i>	30
listelli per bancale • <i>brick-slips x pallet</i>	1680
angolari per scatola • <i>corners x box</i>	16
angolari per bancale • <i>corners x pallet</i>	1024



# Genesis 620

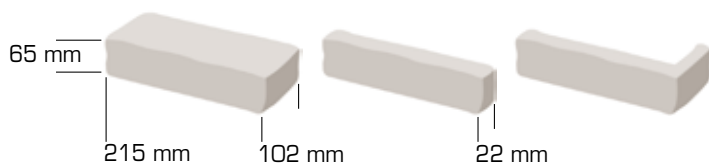
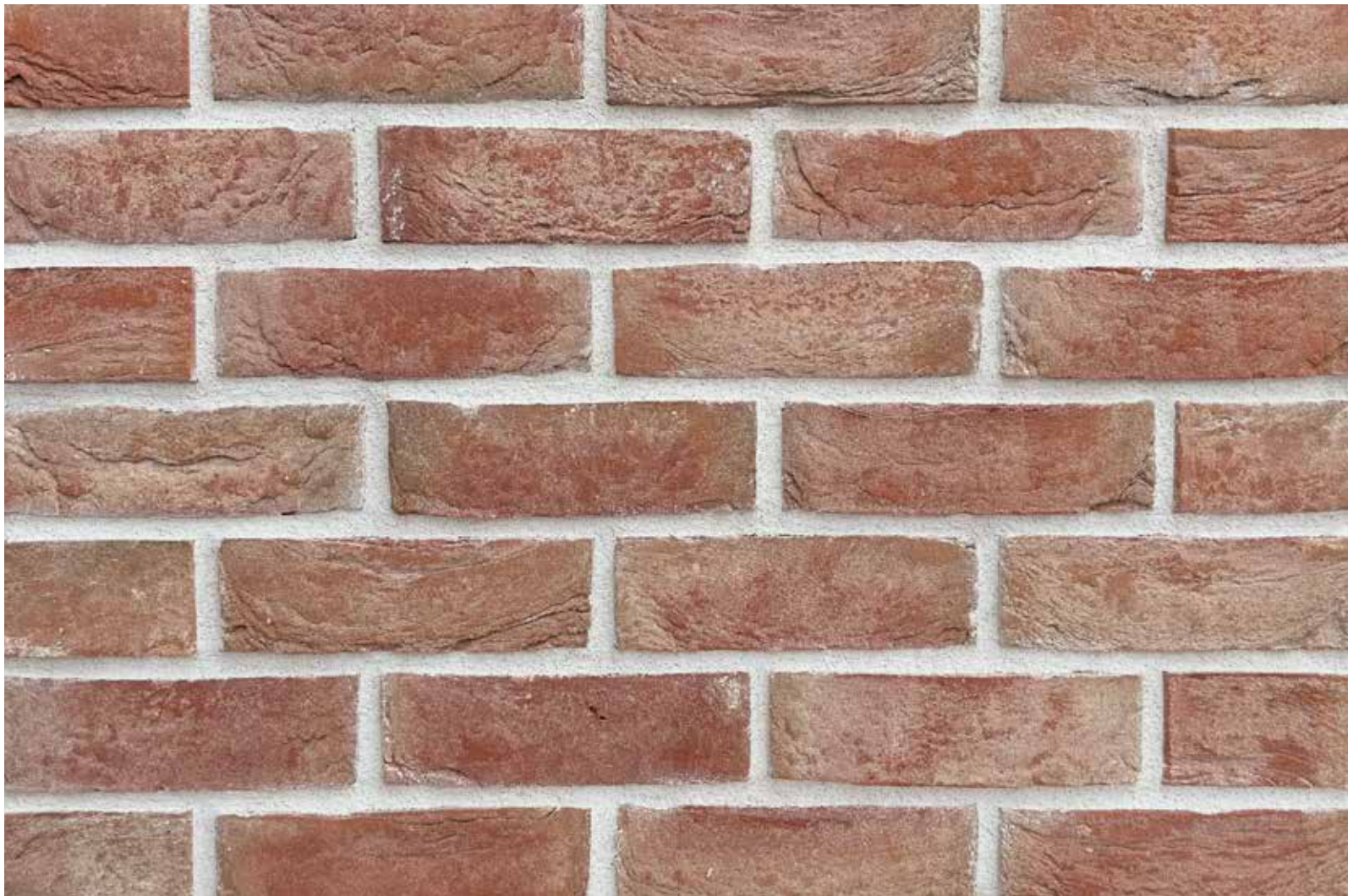

peso mattone • <i>brick weight</i>	± 2,1 Kg
peso listello • <i>brick-slip weight</i>	± 0,45 Kg
pezzi a mq • <i>pieces x sqm</i>	± 58 pcs/m <sup>2</sup>
mattoni per bancale • <i>bricks x pallet</i>	660
listelli per scatola • <i>brick-slips x box</i>	30
listelli per bancale • <i>brick-slips x pallet</i>	1680
angolari per scatola • <i>corners x box</i>	16
angolari per bancale • <i>corners x pallet</i>	1024





Genesis 620





# Genesis 630

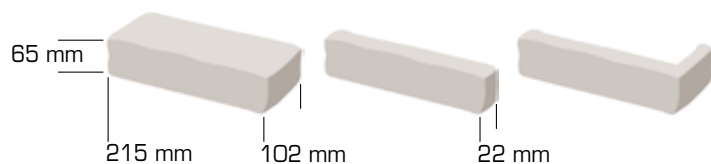
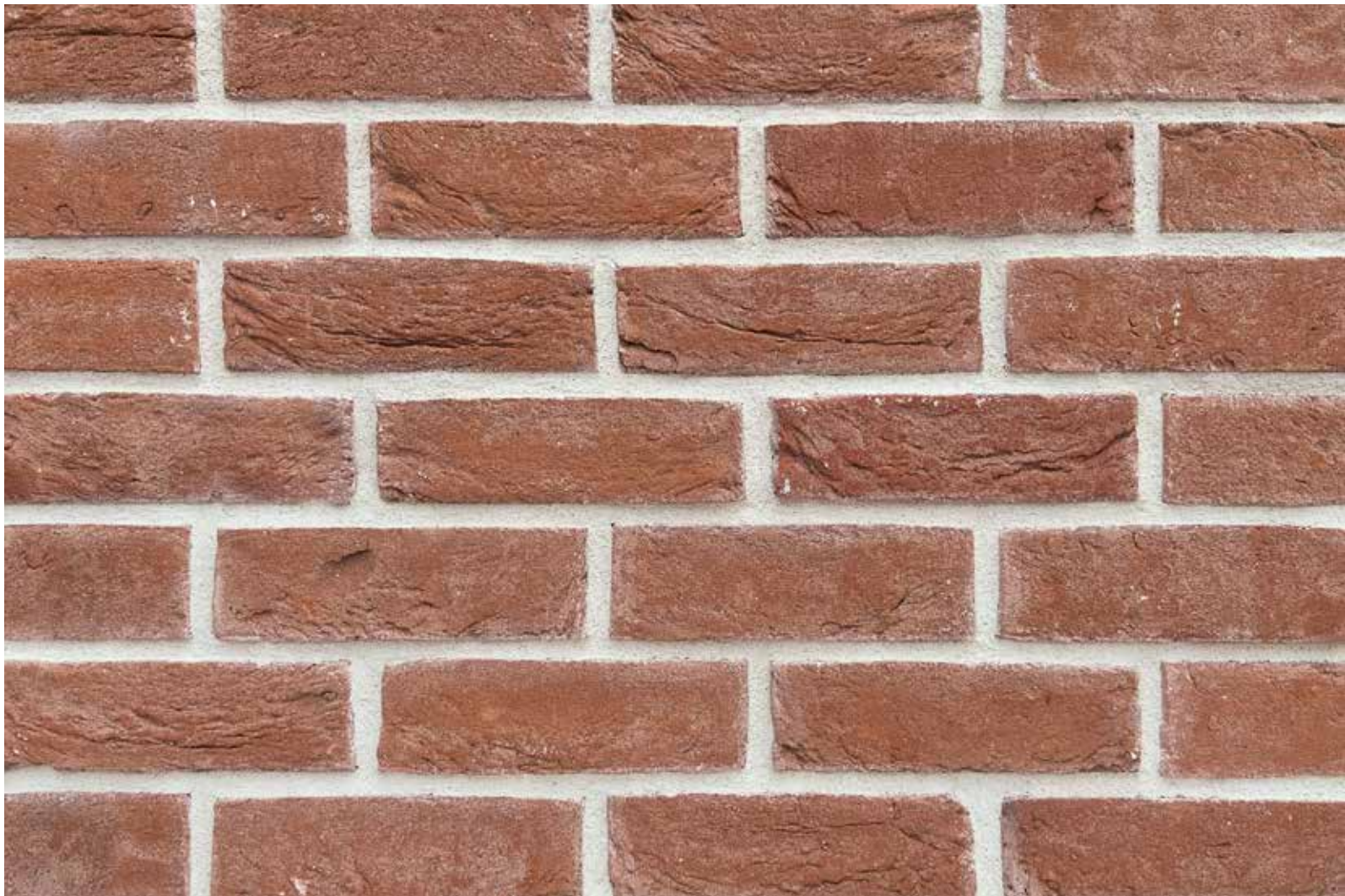

peso mattone • <i>brick weight</i>	± 2,3 Kg
peso listello • <i>brick-slip weight</i>	± 0,45 Kg
pezzi a mq • <i>pieces x sqm</i>	± 58 pcs/m <sup>2</sup>
mattoni per bancale • <i>bricks x pallet</i>	680
listelli per scatola • <i>brick-slips x box</i>	30
listelli per bancale • <i>brick-slips x pallet</i>	1680
angolari per scatola • <i>corners x box</i>	16
angolari per bancale • <i>corners x pallet</i>	1024

















# Genesis 300

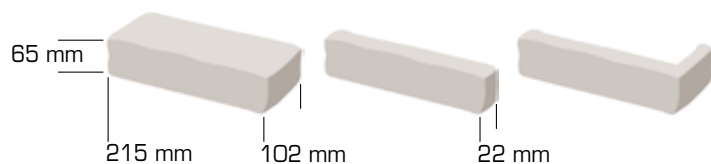

peso mattone • <i>brick weight</i>	± 2,1 Kg
peso listello • <i>brick-slip weight</i>	± 0,45 Kg
pezzi a mq • <i>pieces x sqm</i>	± 58 pcs/m <sup>2</sup>
mattoni per bancale • <i>bricks x pallet</i>	528
listelli per scatola • <i>brick-slips x box</i>	30
listelli per bancale • <i>brick-slips x pallet</i>	1680
angolari per scatola • <i>corners x box</i>	16
angolari per bancale • <i>corners x pallet</i>	1024







Genesis 300







# Genesis 340

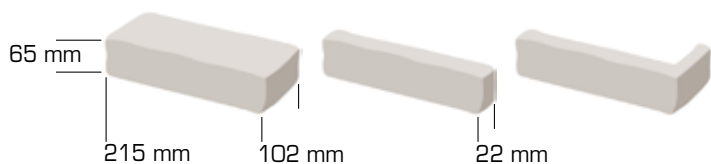

peso mattone • <i>brick weight</i>	± 2,6 Kg
peso listello • <i>brick-slip weight</i>	± 0,45 Kg
pezzi a mq • <i>pieces x sqm</i>	± 58 pcs/m <sup>2</sup>
mattoni per bancale • <i>bricks x pallet</i>	528
listelli per scatola • <i>brick-slips x box</i>	30
listelli per bancale • <i>brick-slips x pallet</i>	1680
angolari per scatola • <i>corners x box</i>	16
angolari per bancale • <i>corners x pallet</i>	1024

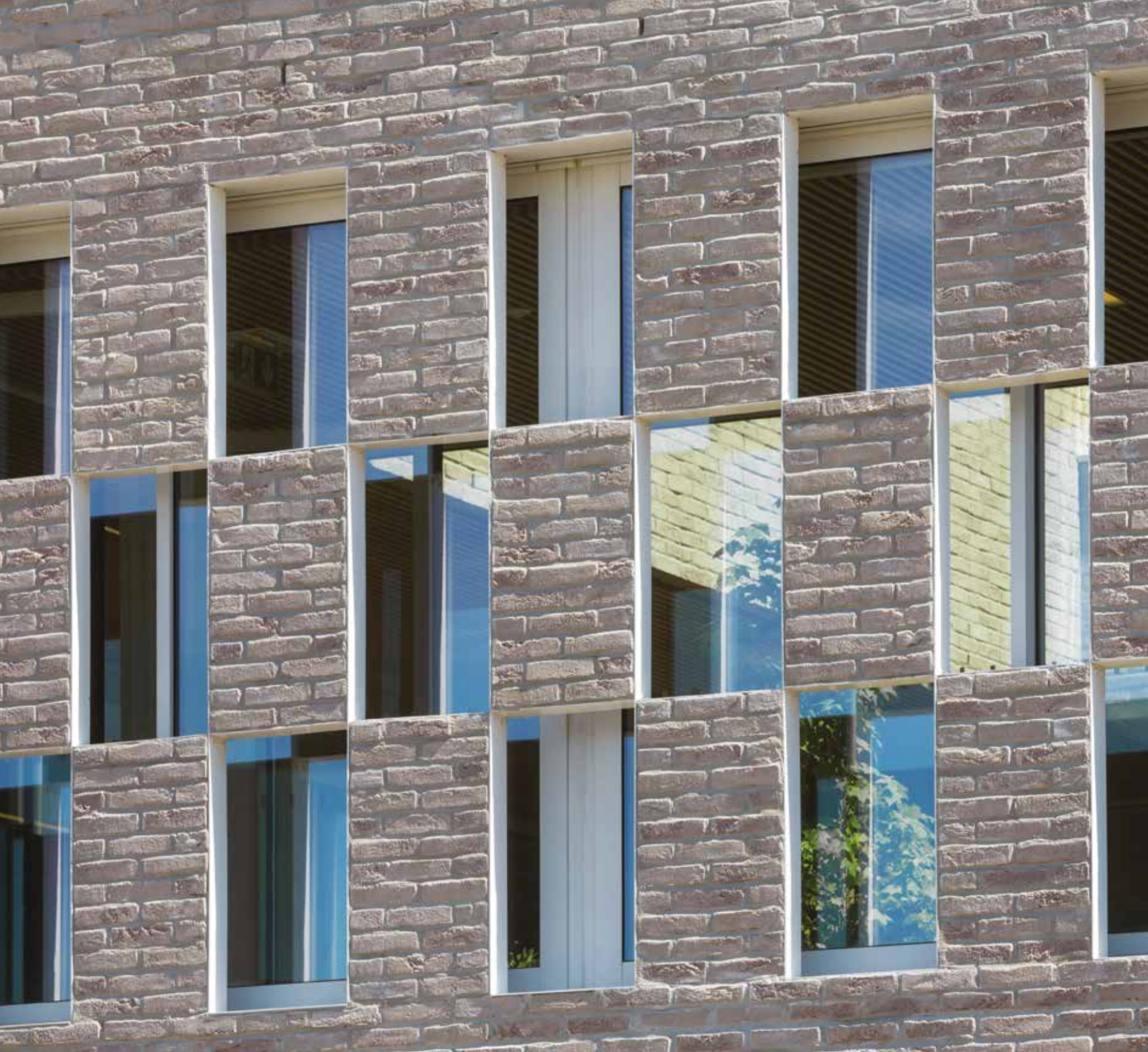

Genesis 340





# Genesis Alfa

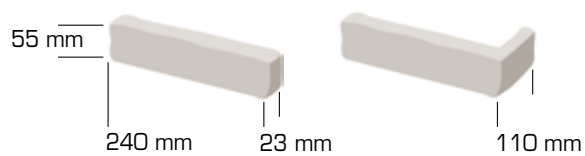

peso listello • <i>brick-slip weight</i>	± 0,40 Kg
pezzi a mq • <i>pieces x sqm</i>	± 62 pcs/m <sup>2</sup>
listelli per scatola • <i>brick-slips x box</i>	30
listelli per bancale • <i>brick-slips x pallet</i>	2.880
angolari per scatola • <i>corners x box</i>	14
angolari per bancale • <i>corners x pallet</i>	1.344

Breitling









Genesis Alfa





# Genesis 002

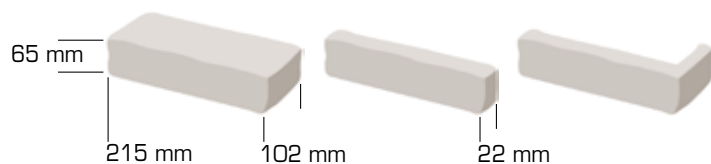

peso mattone • <i>brick weight</i>	± 2,3 Kg
peso listello • <i>brick-slip weight</i>	± 0,45 Kg
pezzi a mq • <i>pieces x sqm</i>	± 58 pcs/m <sup>2</sup>
mattoni per bancale • <i>bricks x pallet</i>	628
listelli per scatola • <i>brick-slips x box</i>	30
listelli per bancale • <i>brick-slips x pallet</i>	1680
angolari per scatola • <i>corners x box</i>	16
angolari per bancale • <i>corners x pallet</i>	1024



I mattoni pieni Genesis 002 sono sottoposti ad un'alterazione superficiale, in modo da ottenere l'aspetto di un mattone di recupero, presentano residui di malta e spigoli arrotondati, che li fanno apparire come se fossero stati esposti alle intemperie per molti anni, alla demolizione ed alla pulizia.

*The surface of the full Genesis 002 bricks undergoes a process that gives them the appearance of old used bricks. The surface mortar residues and rounded edges make them look as if they were exposed to bad weather for many years, then demolished and cleaned.*

# Genesis 260

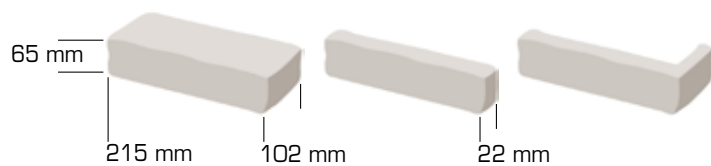

peso mattone • <i>brick weight</i>	± 2,0 Kg
peso listello • <i>brick-slip weight</i>	± 0,45 Kg
pezzi a mq • <i>pieces x sqm</i>	± 58 pcs/m²
mattoni per bancale • <i>bricks x pallet</i>	640
listelli per scatola • <i>brick-slips x box</i>	30
listelli per bancale • <i>brick-slips x pallet</i>	1680
angolari per scatola • <i>corners x box</i>	16
angolari per bancale • <i>corners x pallet</i>	1024



# Genesis 250

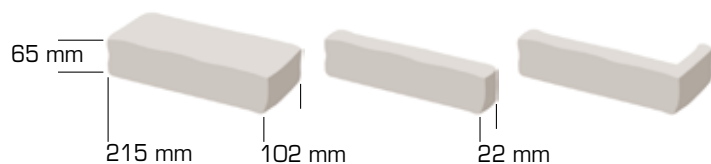
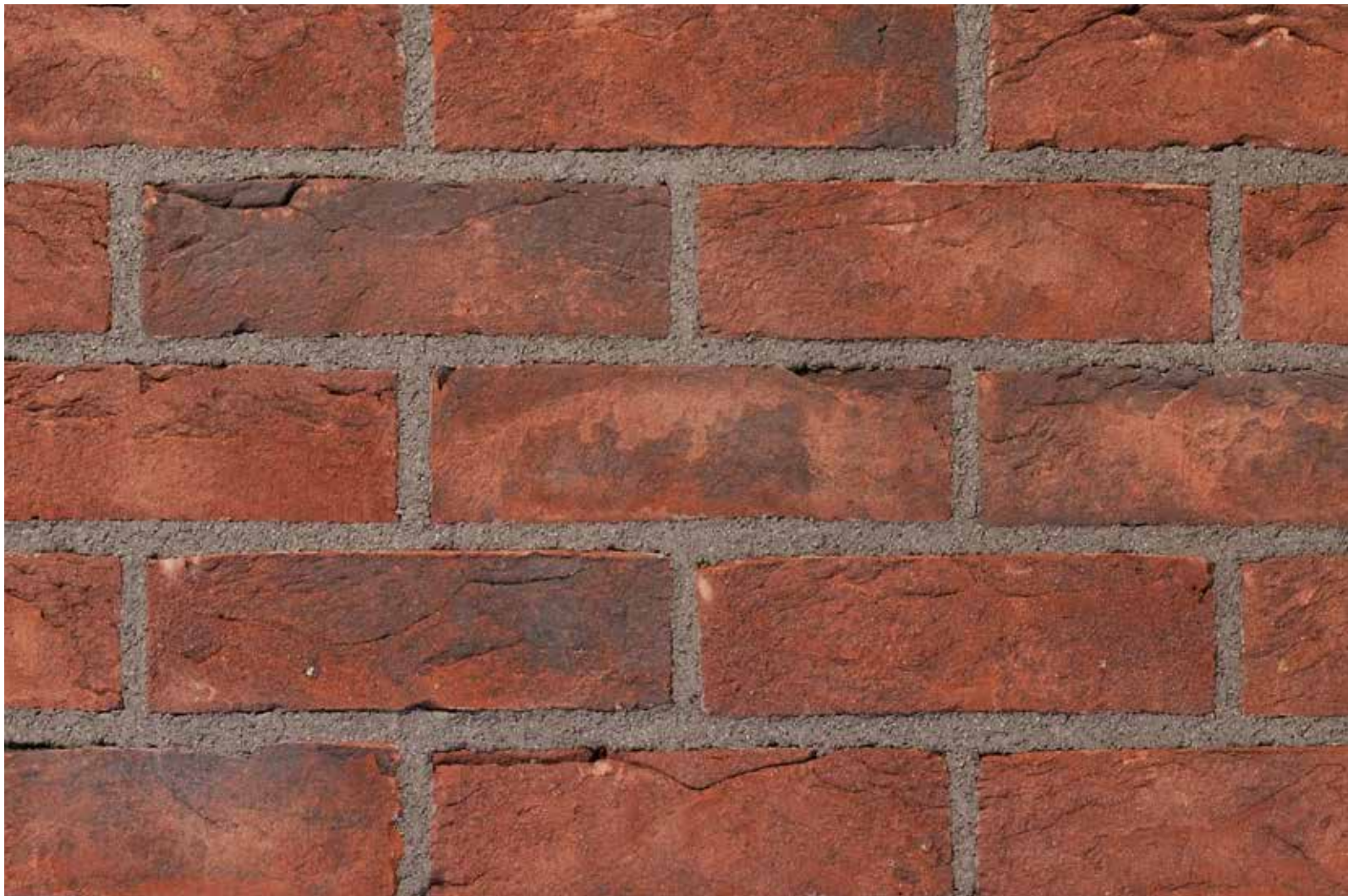

peso mattone • <i>brick weight</i>	± 2,3 Kg
peso listello • <i>brick-slip weight</i>	± 0,45 Kg
pezzi a mq • <i>pieces x sqm</i>	± 58 pcs/m <sup>2</sup>
mattoni per bancale • <i>bricks x pallet</i>	528
listelli per scatola • <i>brick-slips x box</i>	30
listelli per bancale • <i>brick-slips x pallet</i>	1680
angolari per scatola • <i>corners x box</i>	16
angolari per bancale • <i>corners x pallet</i>	1024









# Genesis 490

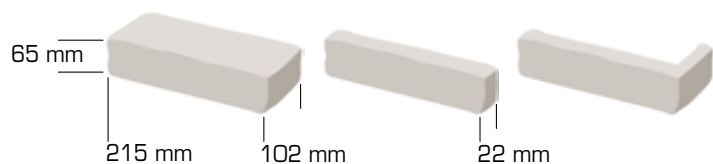

peso mattone • <i>brick weight</i>	± 2,6 Kg
peso listello • <i>brick-slip weight</i>	± 0,45 Kg
pezzi a mq • <i>pieces x sqm</i>	± 58 pcs/m <sup>2</sup>
mattoni per bancale • <i>bricks x pallet</i>	528
listelli per scatola • <i>brick-slips x box</i>	30
listelli per bancale • <i>brick-slips x pallet</i>	1680
angolari per scatola • <i>corners x box</i>	16
angolari per bancale • <i>corners x pallet</i>	1024



# Genesis 500

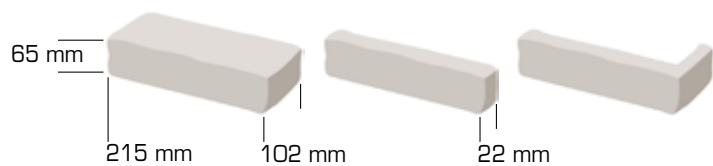

peso mattone • <i>brick weight</i>	± 2,6 Kg
peso listello • <i>brick-slip weight</i>	± 0,45 Kg
pezzi a mq • <i>pieces x sqm</i>	± 58 pcs/m <sup>2</sup>
mattoni per bancale • <i>bricks x pallet</i>	528
listelli per scatola • <i>brick-slips x box</i>	30
listelli per bancale • <i>brick-slips x pallet</i>	1680
angolari per scatola • <i>corners x box</i>	16
angolari per bancale • <i>corners x pallet</i>	1024



Studio FTG architettura e ingegneria di Ollocco













## Genesis 500



Studio FTG architettura e ingegneria di Olocco

# Genesis 600

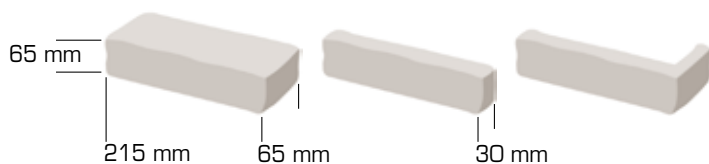

peso mattone • <i>brick weight</i>	± 1,6 Kg
peso listello • <i>brick-slip weight</i>	± 0,70 Kg
pezzi a mq • <i>pieces x sqm</i>	± 58 pcs/m²
mattoni per bancale • <i>bricks x pallet</i>	904
listelli per scatola • <i>brick-slips x box</i>	23
listelli per bancale • <i>brick-slips x pallet</i>	1.288
angolari per scatola • <i>corners x box</i>	16
angolari per bancale • <i>corners x pallet</i>	1.024









# Genesis 390

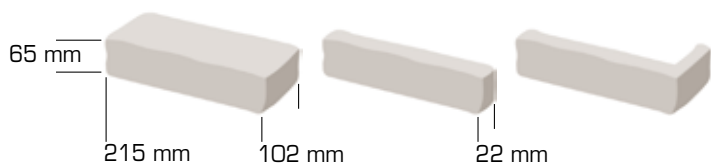

peso mattone • <i>brick weight</i>	± 2,1 Kg
peso listello • <i>brick-slip weight</i>	± 0,45 Kg
pezzi a mq • <i>pieces x sqm</i>	± 58 pcs/m <sup>2</sup>
mattoni per bancale • <i>bricks x pallet</i>	628
listelli per scatola • <i>brick-slips x box</i>	30
listelli per bancale • <i>brick-slips x pallet</i>	1.680
angolari per scatola • <i>corners x box</i>	16
angolari per bancale • <i>corners x pallet</i>	1.024



# Genesis 320

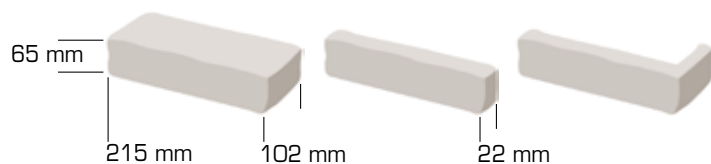
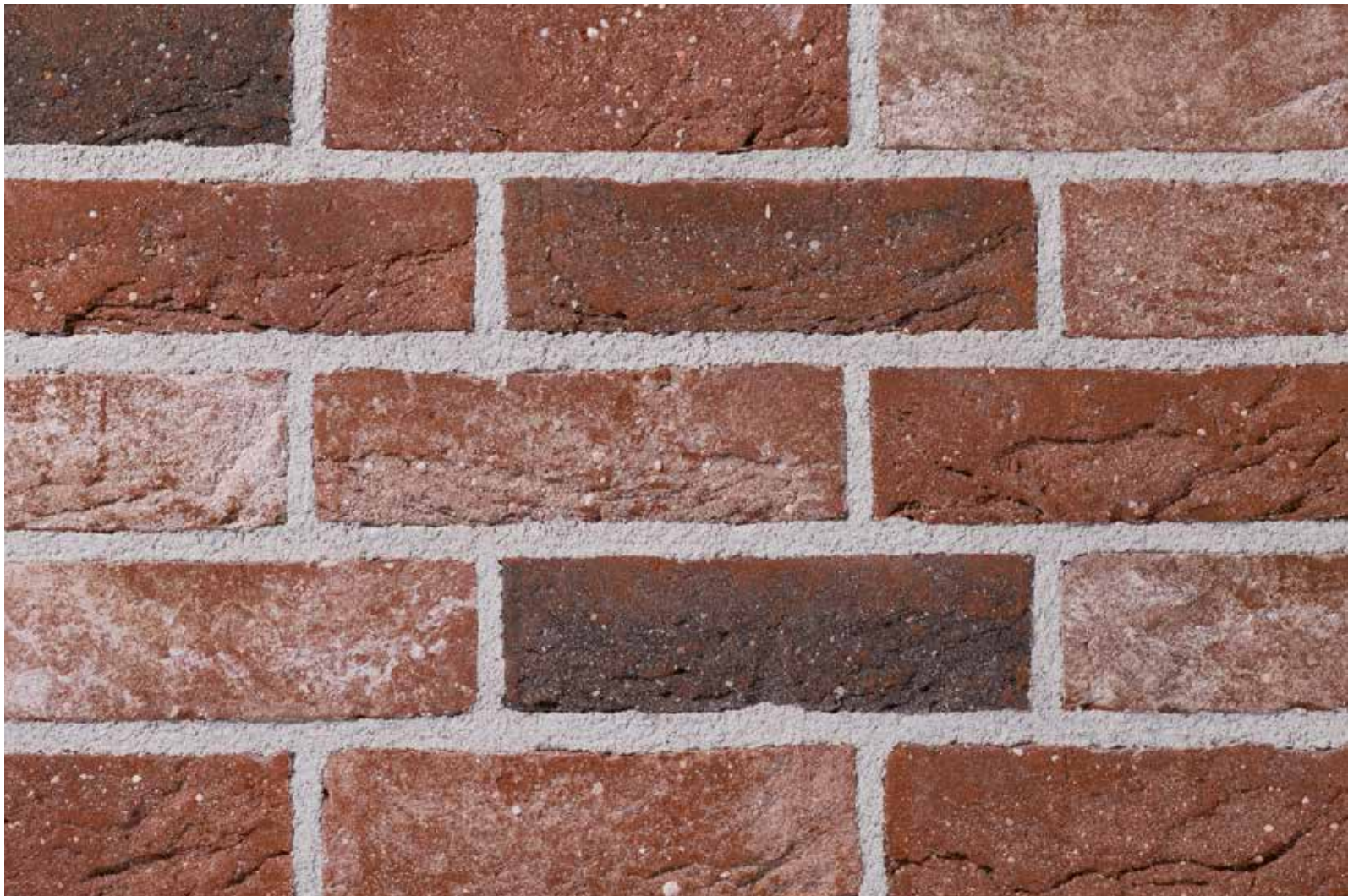

peso mattone • <i>brick weight</i>	± 2,5 Kg
peso listello • <i>brick-slip weight</i>	± 0,50 Kg
pezzi a mq • <i>pieces x sqm</i>	± 58 pcs/m <sup>2</sup>
mattoni per bancale • <i>bricks x pallet</i>	528
listelli per scatola • <i>brick-slips x box</i>	30
listelli per bancale • <i>brick-slips x pallet</i>	1.680
angolari per scatola • <i>corners x box</i>	16
angolari per bancale • <i>corners x pallet</i>	1.024







# Genesis 550

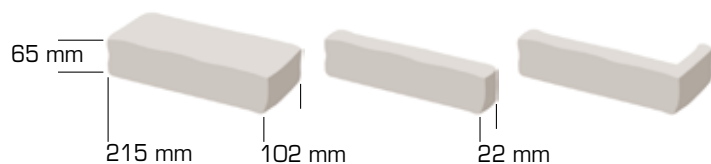

peso mattone • <i>brick weight</i>	± 2,5 Kg
peso listello • <i>brick-slip weight</i>	± 0,45 Kg
pezzi a mq • <i>pieces x sqm</i>	± 58 pcs/m <sup>2</sup>
mattoni per bancale • <i>bricks x pallet</i>	528
listelli per scatola • <i>brick-slips x box</i>	30
listelli per bancale • <i>brick-slips x pallet</i>	1.680
angolari per scatola • <i>corners x box</i>	16
angolari per bancale • <i>corners x pallet</i>	1.024



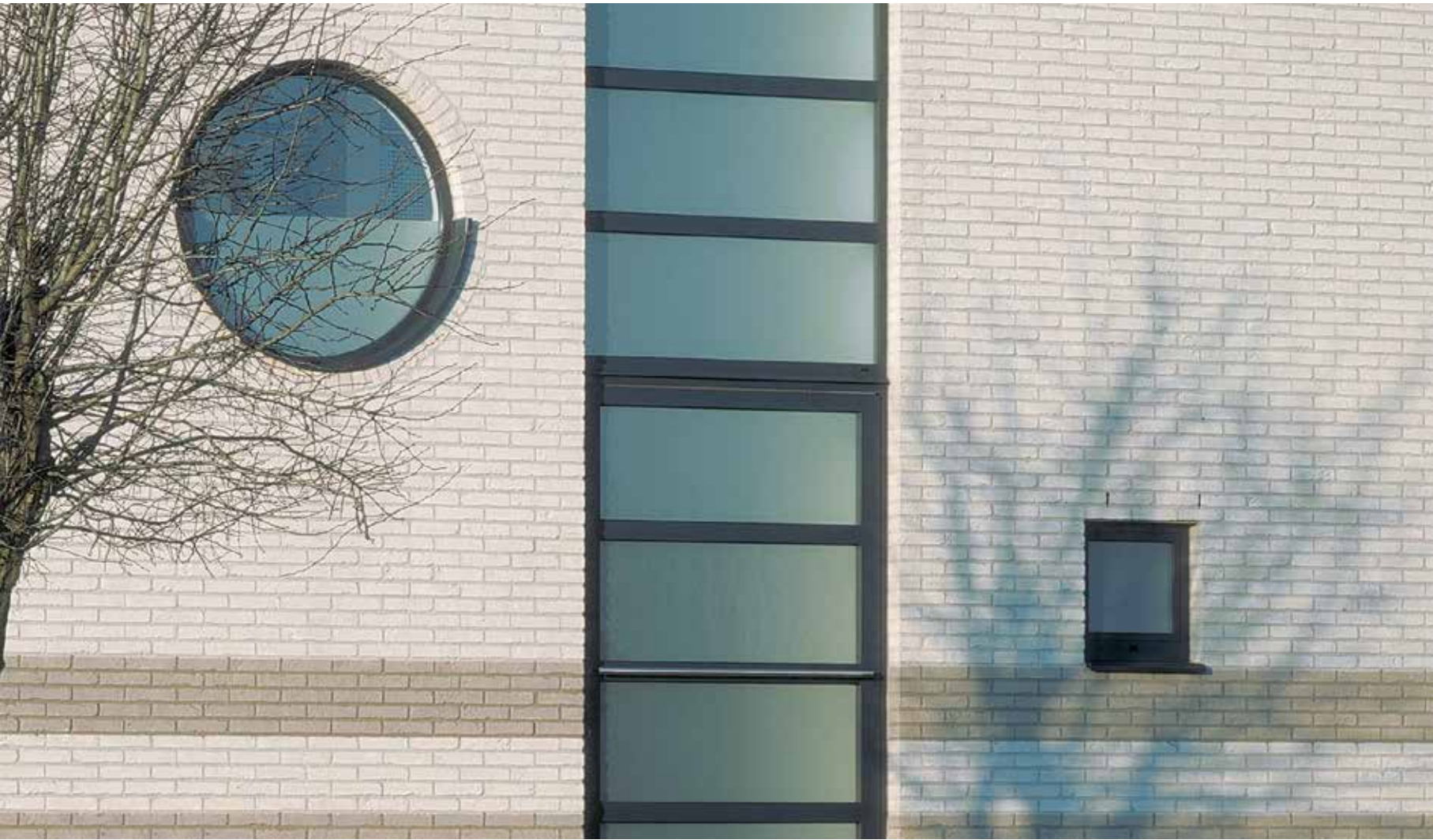

# Genesis 450

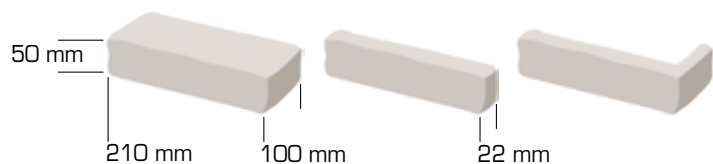

peso mattone • <i>brick weight</i>	± 1,7 Kg
peso listello • <i>brick-slip weight</i>	± 0,40 Kg
pezzi a mq • <i>pieces x sqm</i>	± 73 pcs/m <sup>2</sup>
mattoni per bancale • <i>bricks x pallet</i>	900
listelli per scatola • <i>brick-slips x box</i>	30
listelli per bancale • <i>brick-slips x pallet</i>	1.680
angolari per scatola • <i>corners x box</i>	16
angolari per bancale • <i>corners x pallet</i>	1.024



# Genesis 700

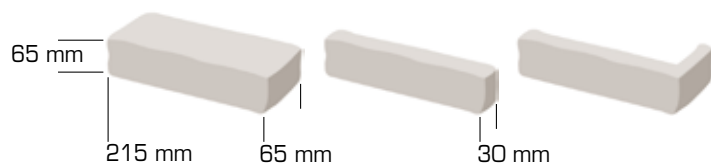

peso mattone • <i>brick weight</i>	± 1,7 Kg
peso listello • <i>brick-slip weight</i>	± 0,70 Kg
pezzi a mq • <i>pieces x sqm</i>	± 58 pcs/m <sup>2</sup>
mattoni per bancale • <i>bricks x pallet</i>	850
listelli per scatola • <i>brick-slips x box</i>	23
listelli per bancale • <i>brick-slips x pallet</i>	1.288
angolari per scatola • <i>corners x box</i>	16
angolari per bancale • <i>corners x pallet</i>	1.024



# Genesis 190

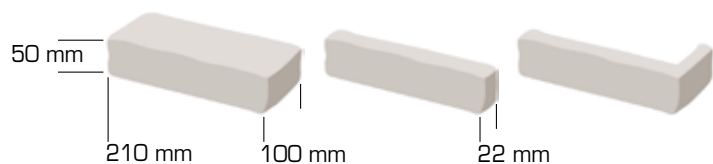
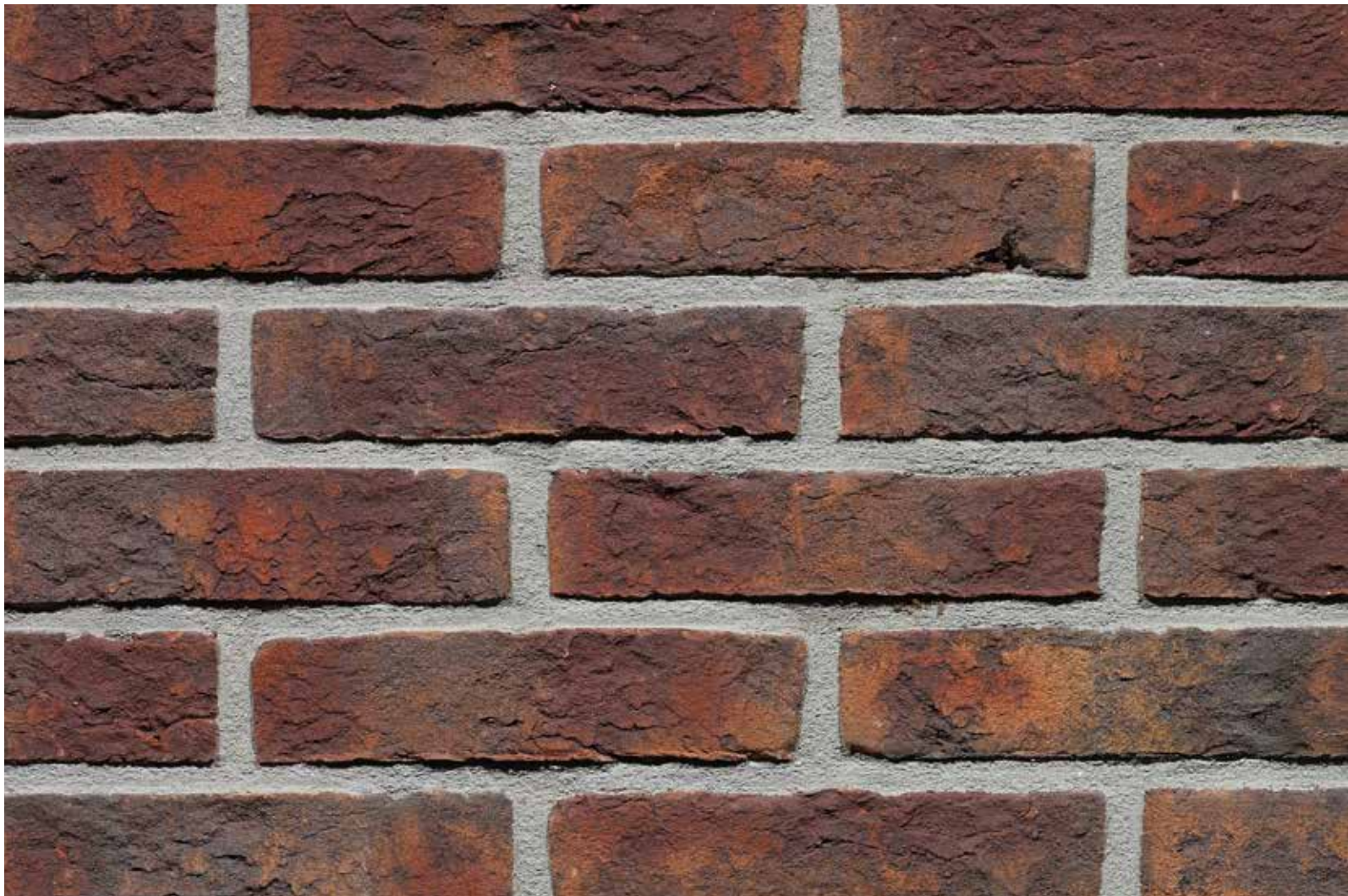

peso mattone • <i>brick weight</i>	± 1,7 Kg
peso listello • <i>brick-slip weight</i>	± 0,40 Kg
pezzi a mq • <i>pieces x sqm</i>	± 73 pcs/m <sup>2</sup>
mattoni per bancale • <i>bricks x pallet</i>	376
listelli per scatola • <i>brick-slips x box</i>	30
listelli per bancale • <i>brick-slips x pallet</i>	1.680
angolari per scatola • <i>corners x box</i>	16
angolari per bancale • <i>corners x pallet</i>	1.024



# Genesis 220

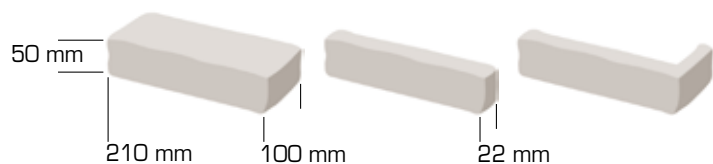

peso mattone • <i>brick weight</i>	± 1,7 Kg
peso listello • <i>brick-slip weight</i>	± 0,40 Kg
pezzi a mq • <i>pieces x sqm</i>	± 73 pcs/m <sup>2</sup>
mattoni per bancale • <i>bricks x pallet</i>	440
listelli per scatola • <i>brick-slips x box</i>	30
listelli per bancale • <i>brick-slips x pallet</i>	1.680
angolari per scatola • <i>corners x box</i>	16
angolari per bancale • <i>corners x pallet</i>	1.024





# Genesis 440

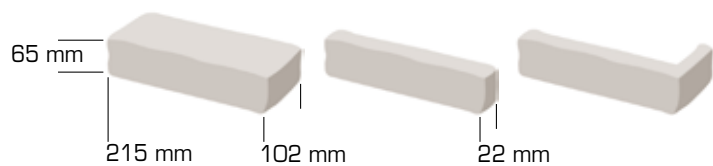

peso mattone • <i>brick weight</i>	± 2,1 Kg
peso listello • <i>brick-slip weight</i>	± 0,45 Kg
pezzi a mq • <i>pieces x sqm</i>	± 58 pcs/m <sup>2</sup>
mattoni per bancale • <i>bricks x pallet</i>	628
listelli per scatola • <i>brick-slips x box</i>	30
listelli per bancale • <i>brick-slips x pallet</i>	1.680
angolari per scatola • <i>corners x box</i>	16
angolari per bancale • <i>corners x pallet</i>	1.024



# Genesis 240

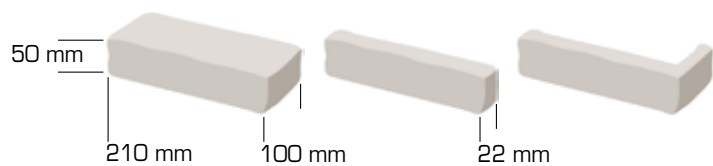

peso mattone • <i>brick weight</i>	± 1,7 Kg
peso listello • <i>brick-slip weight</i>	± 0,40 Kg
pezzi a mq • <i>pieces x sqm</i>	± 73 pcs/m <sup>2</sup>
mattoni per bancale • <i>bricks x pallet</i>	376
listelli per scatola • <i>brick-slips x box</i>	30
listelli per bancale • <i>brick-slips x pallet</i>	1.680
angolari per scatola • <i>corners x box</i>	16
angolari per bancale • <i>corners x pallet</i>	1.024



# Genesis 270

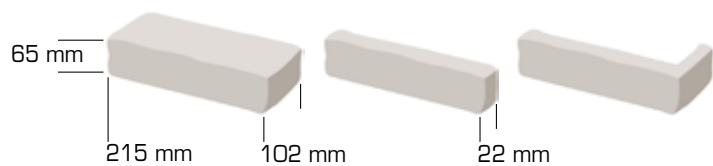

peso mattone • <i>brick weight</i>	± 2,2 Kg
peso listello • <i>brick-slip weight</i>	± 0,45 Kg
pezzi a mq • <i>pieces x sqm</i>	± 58 pcs/m <sup>2</sup>
mattoni per bancale • <i>bricks x pallet</i>	660
listelli per scatola • <i>brick-slips x box</i>	30
listelli per bancale • <i>brick-slips x pallet</i>	1.680
angolari per scatola • <i>corners x box</i>	16
angolari per bancale • <i>corners x pallet</i>	1.024



# Genesis 660

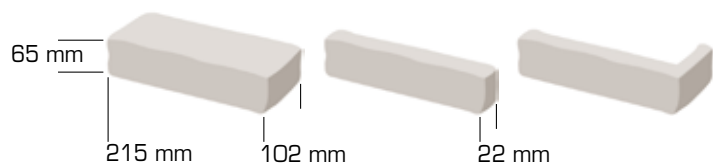

peso mattone • <i>brick weight</i>	± 2,6 Kg
peso listello • <i>brick-slip weight</i>	± 0,45 Kg
pezzi a mq • <i>pieces x sqm</i>	± 58 pcs/m <sup>2</sup>
mattoni per bancale • <i>bricks x pallet</i>	528
listelli per scatola • <i>brick-slips x box</i>	30
listelli per bancale • <i>brick-slips x pallet</i>	1.680
angolari per scatola • <i>corners x box</i>	16
angolari per bancale • <i>corners x pallet</i>	1.024





Architect Deleu Koen Architectenvennootschap, Rumbeke

# Genesis 660



Uzien Fotografie Hassel



# Genesis E80

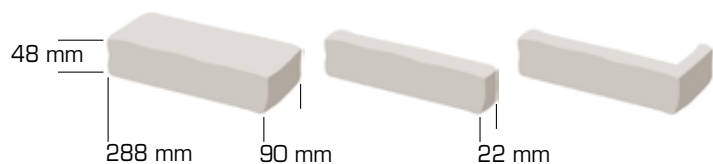

peso mattone • <i>brick weight</i>	± 2,1 Kg
peso listello • <i>brick-slip weight</i>	± 0,50 Kg
pezzi a mq • <i>pieces x sqm</i>	± 56 pcs/m <sup>2</sup>
mattoni per bancale • <i>bricks x pallet</i>	804



Architect RE-ST Architectenvenootschap

# Genesis E90

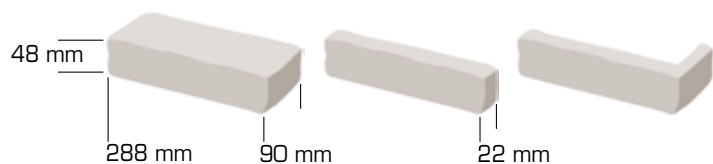

peso mattone • <i>brick weight</i>	± 2,0 Kg
peso listello • <i>brick-slip weight</i>	± 0,45 Kg
pezzi a mq • <i>pieces x sqm</i>	± 56 pcs/m <sup>2</sup>
mattoni per bancale • <i>bricks x pallet</i>	804



Architect Atelier 4: Architecten, Peter van Driessche, Gent

# Genesis L10

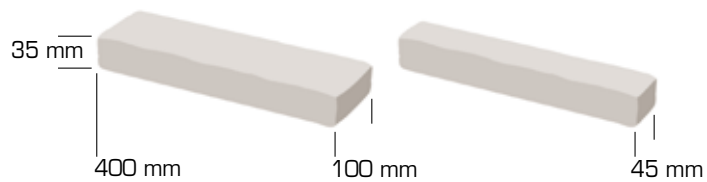
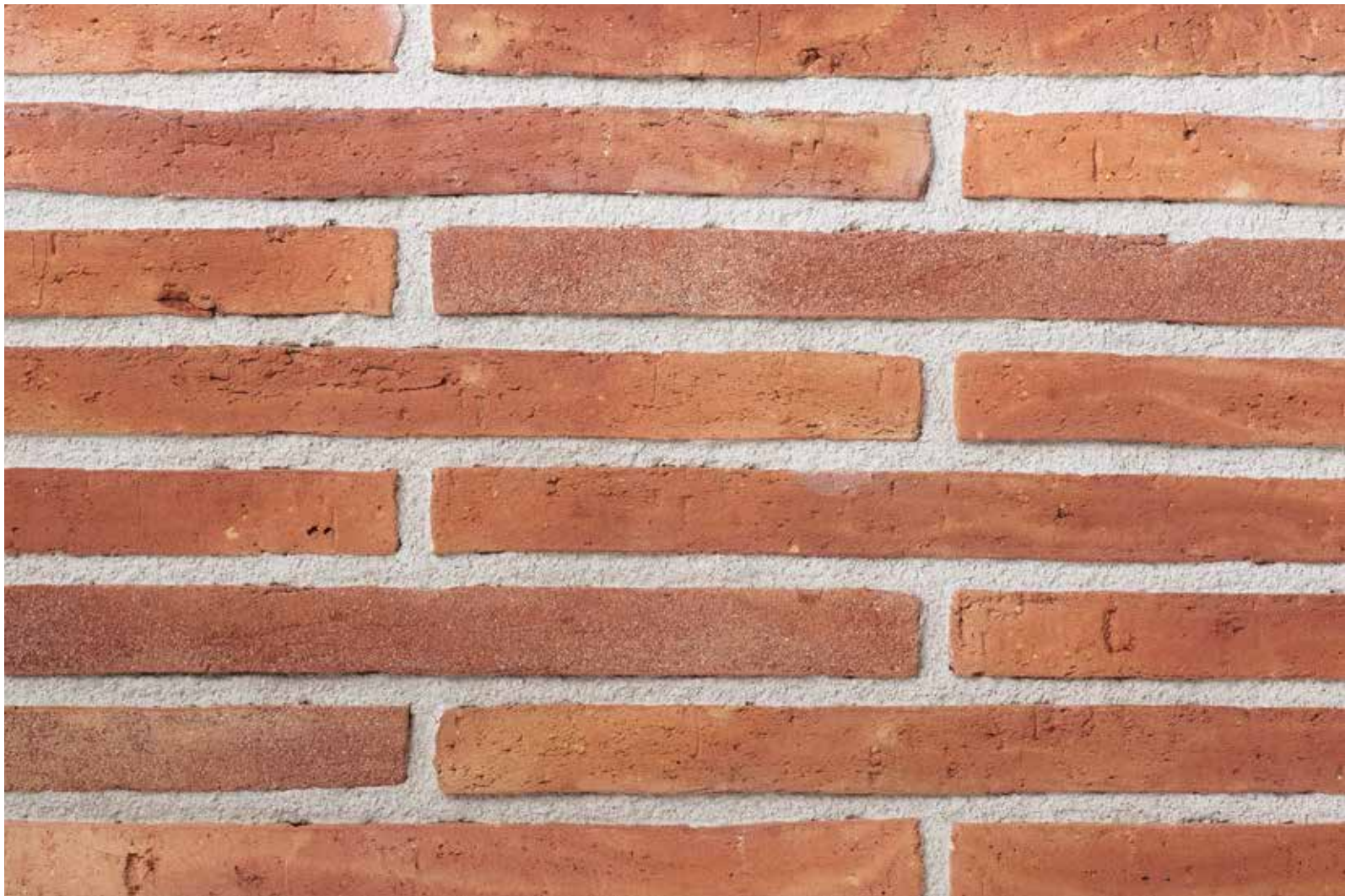

peso mattone • <i>brick weight</i>	± 2,5 Kg
peso listello • <i>brick-slip weight</i>	± 1,20 Kg
pezzi a mq • <i>pieces x sqm</i>	± 50 pcs/m <sup>2</sup>
mattoni per bancale • <i>bricks x pallet</i>	600
listelli per bancale • <i>brick-slips x pallet</i>	550





# Genesis L12

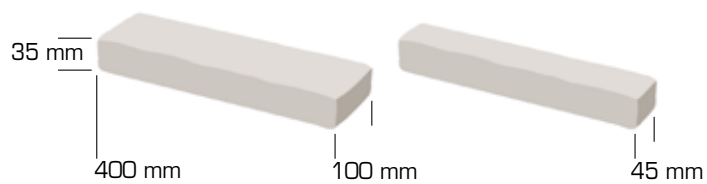

peso mattone • <i>brick weight</i>	± 2,5 Kg
peso listello • <i>brick-slip weight</i>	± 1,20 Kg
pezzi a mq • <i>pieces x sqm</i>	± 50 pcs/m <sup>2</sup>
mattoni per bancale • <i>bricks x pallet</i>	600
listelli per bancale • <i>brick-slips x pallet</i>	550







Rivestimenti Naturali

# Grande R  serve

## Mattoni e listelli faccia a vista

### Unici al mondo

Grande R  serve   una linea di mattoni faccia a vista di infinito pregio che rende ogni progetto unico perch  unico   ogni mattone. Questa particolare gamma si presenta in produzione limitata, frutto di una sapiente selezione di argille e di una lenta cottura che raggiunge gradualmente i 1200  in un forno circolare dei primi del '900. Fatti ancora come un tempo, i mattoni Grande R  serve donano una forte personalit  a qualsiasi ambiente.

### *Facing bricks and brick-slips*

### **Unique in the world**

*Grande R  serve is a line of priceless facing bricks that make every project unique because every brick is unique. This particular range is produced in a limited number. It is the result of an expert selection of clays and a slow firing that gradually reaches 1200  in a circular oven from the early 1900s. Made like they used to be, Grande R  serve bricks instil any environment with a strong personality.*





# Grande Réserve

## **Eccellenza centenaria**

Artigianali e ricercati, i mattoni Grande Réserve conferiscono alle realizzazioni una raffinatezza che non passa inosservata. Ideali per avveniristiche architetture di design o per ricreare facciate interne ed esterne dal sapore antico, i Grande Réserve fanno di ogni casa uno spettacolo da ammirare.

## ***Centuries' old excellence***

*Artisanal and refined, Grande Réserve bricks bestow projects with an elegance that will not go unnoticed. Ideal for trendsetting design architecture or for remaking internal and external walls with an old-fashioned feel, the Grande Réserve bricks make every home a spectacle to be admired.*







15

**giorni di cottura**  
*firing days*

27.000

**mattoni sfornati ogni giorno**  
*bricks baked every day*

300.000

**mattoni per ciclo produttivo**  
*bricks per production cycle*

## Grande Réserve 5

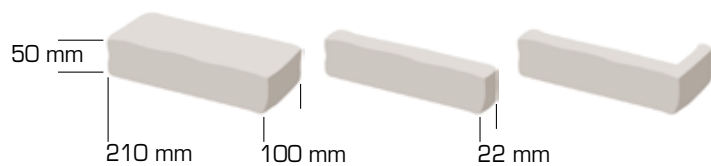
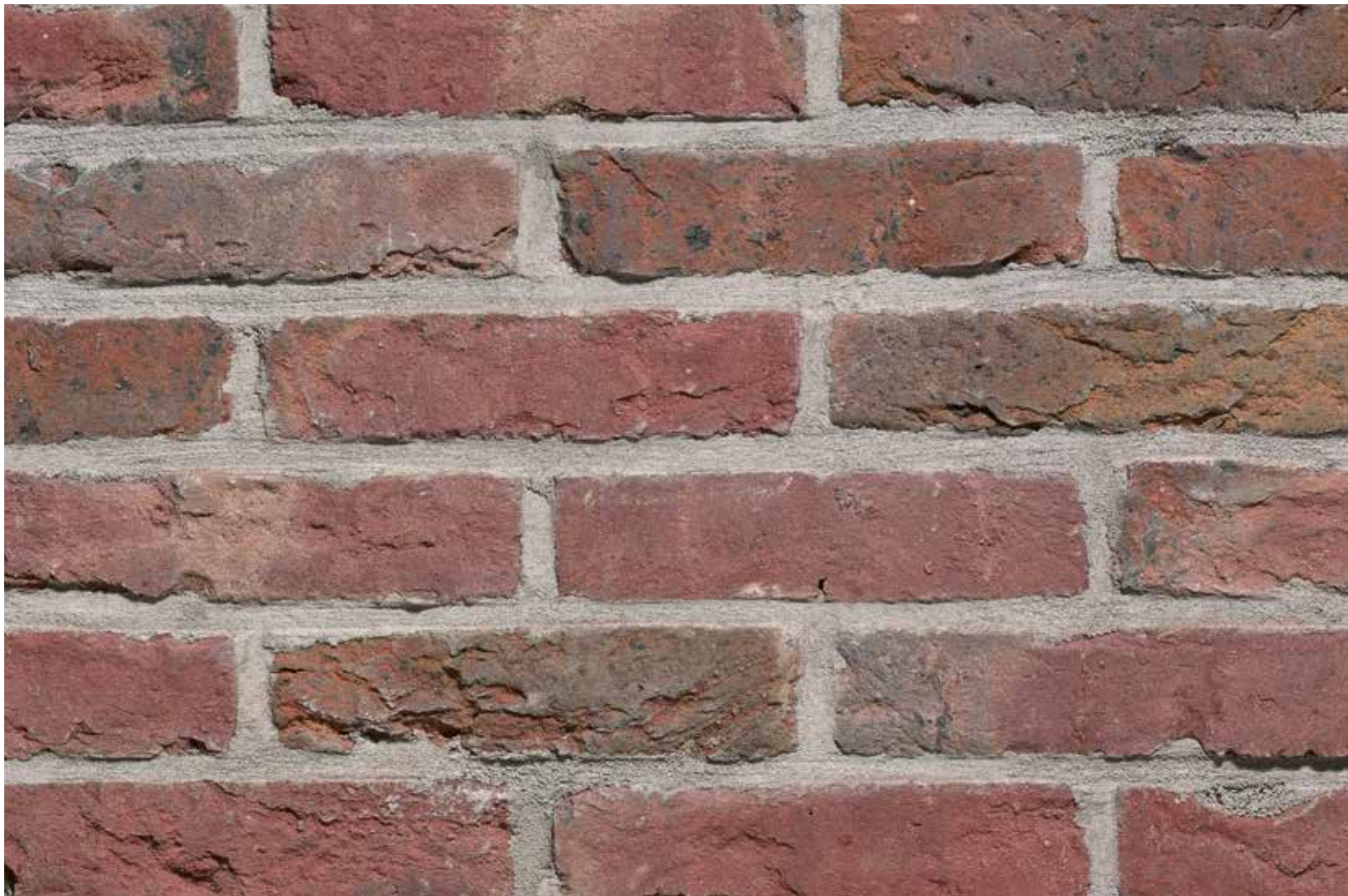

peso mattone • <i>brick weight</i>	± 1,9 Kg
peso listello • <i>brick-slip weight</i>	± 0,40 Kg
pezzi a mq • <i>pieces x sqm</i>	± 76 pcs/m <sup>2</sup>
mattoni per bancale • <i>bricks x pallet</i>	630
listelli per scatola • <i>brick-slips x box</i>	30
listelli per bancale • <i>brick-slips x pallet</i>	1.680
angolari per scatola • <i>corners x box</i>	16
angolari per bancale • <i>corners x pallet</i>	1.024







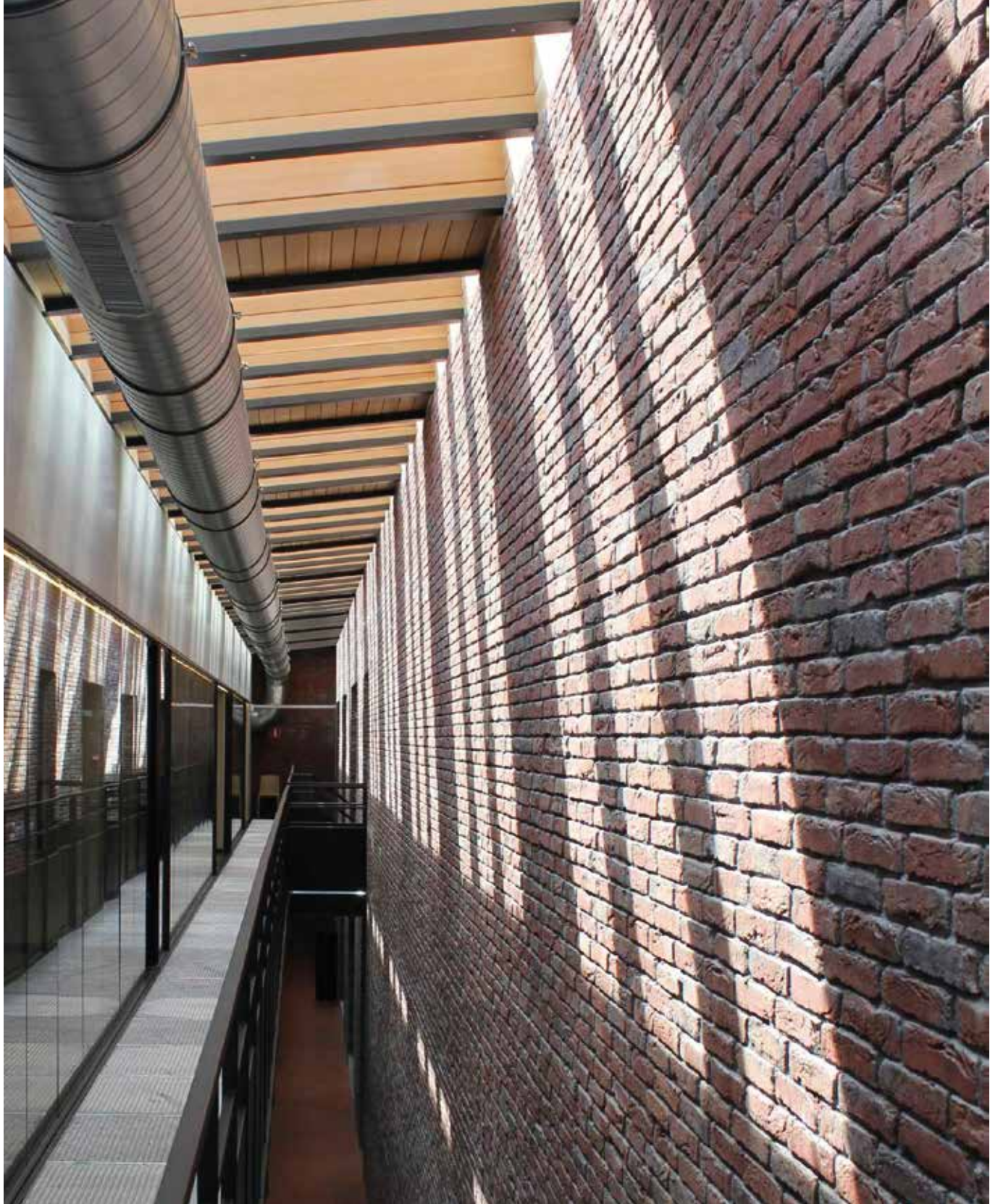



## Grande Réserve 7

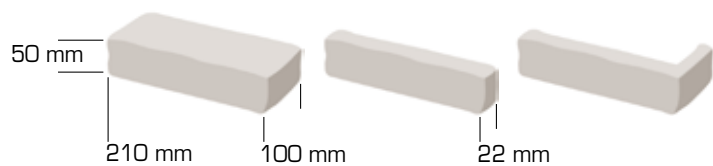
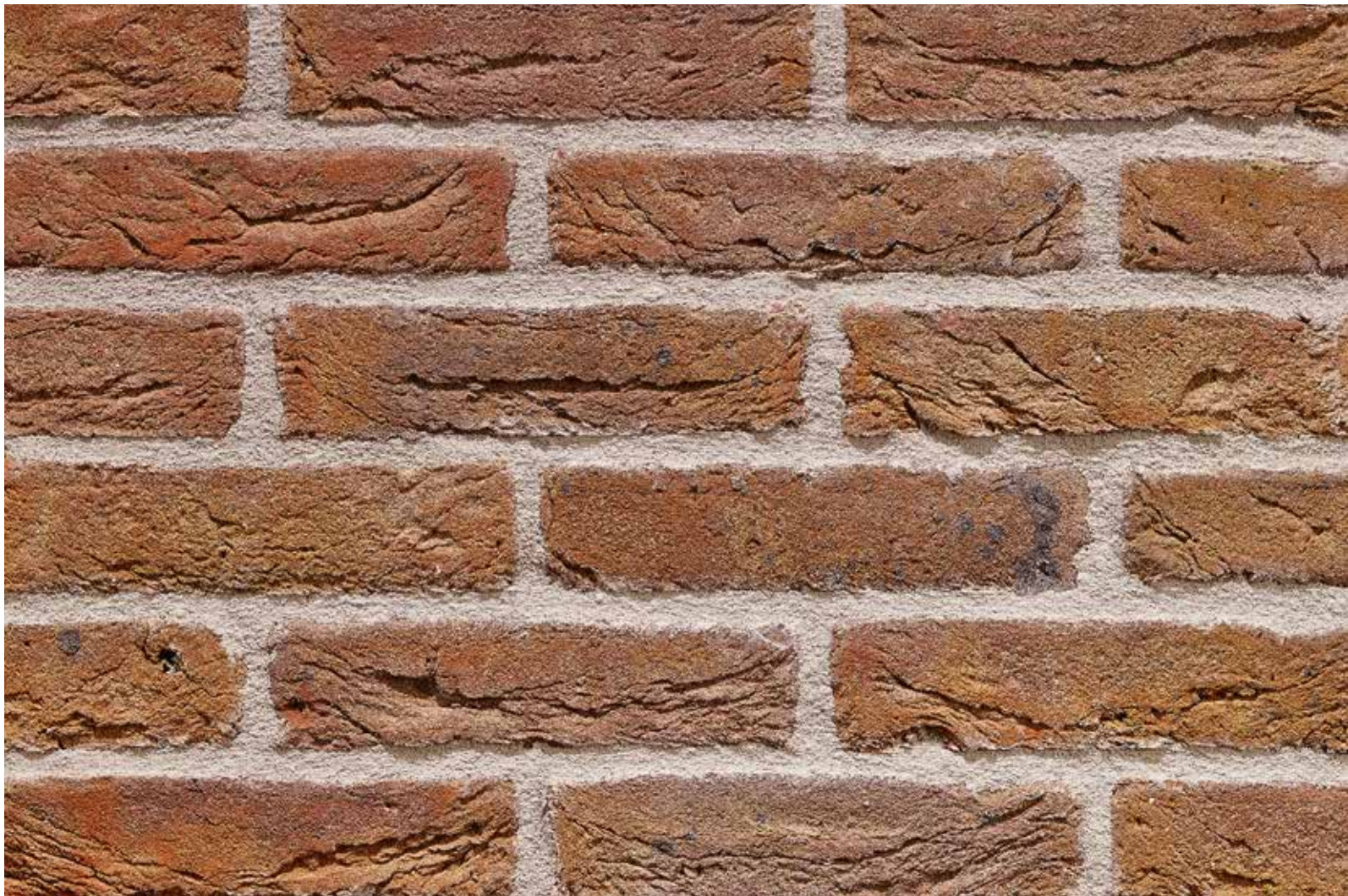

peso mattone • <i>brick weight</i>	± 1,9 Kg
peso listello • <i>brick-slip weight</i>	± 0,40 Kg
pezzi a mq • <i>pieces x sqm</i>	± 76 pcs/m <sup>2</sup>
mattoni per bancale • <i>bricks x pallet</i>	630
listelli per scatola • <i>brick-slips x box</i>	30
listelli per bancale • <i>brick-slips x pallet</i>	1.680
angolari per scatola • <i>corners x box</i>	16
angolari per bancale • <i>corners x pallet</i>	1.024





# Grande Réserve T50

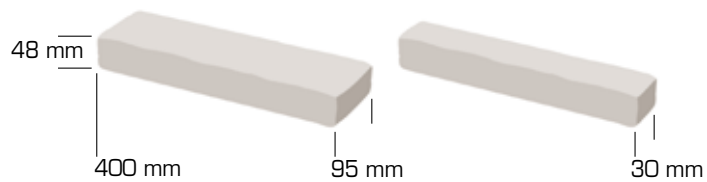
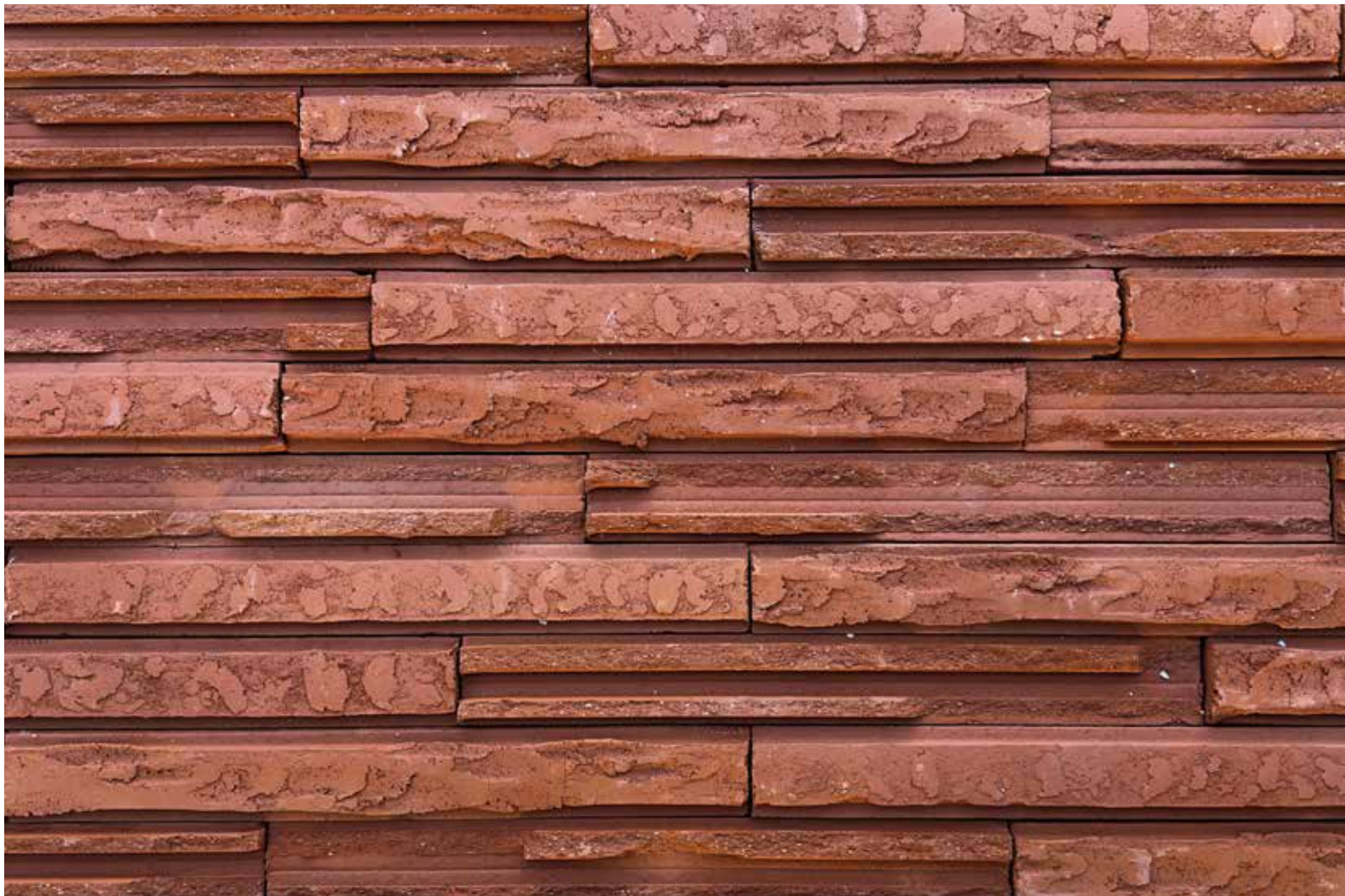

peso mattone • <i>brick weight</i>	± 4,0 Kg
peso listello • <i>brick-slip weight</i>	± 1,20 Kg
pezzi a mq • <i>pieces x sqm</i>	± 41 pcs/m <sup>2</sup>
mattoni per bancale • <i>bricks x pallet</i>	256



# Grande Réserve T52

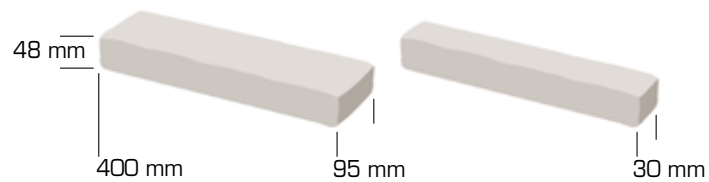

peso mattone • <i>brick weight</i>	± 4,0 Kg
peso listello • <i>brick-slip weight</i>	± 1,20 Kg
pezzi a mq • <i>pieces x sqm</i>	± 41 pcs/m <sup>2</sup>
mattoni per bancale • <i>bricks x pallet</i>	256



# Grande Réserve T52





# Grande Réserve E20

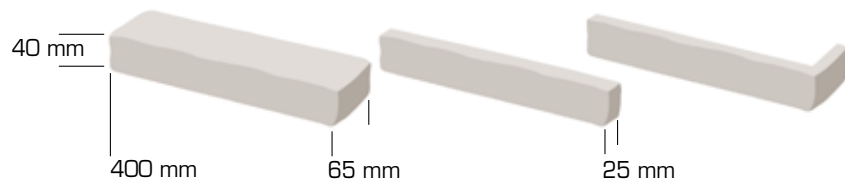

peso mattone • <i>brick weight</i>	± 2,2 Kg
peso listello • <i>brick-slip weight</i>	± 0,80 Kg
pezzi a mq • <i>pieces x sqm</i>	± 49 pcs/m <sup>2</sup>
mattoni per bancale • <i>bricks x pallet</i>	360





# Grande Réserve E22

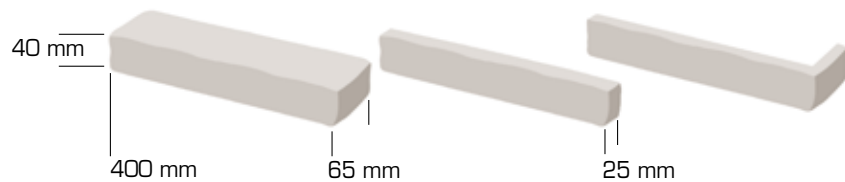

peso mattone • <i>brick weight</i>	± 2,2 Kg
peso listello • <i>brick-slip weight</i>	± 0,80 Kg
pezzi a mq • <i>pieces x sqm</i>	± 49 pcs/m <sup>2</sup>
mattoni per bancale • <i>bricks x pallet</i>	360



Architect De Beenhouwer - Léonard Architecten, Antwerpen

# Grande Réserve W40

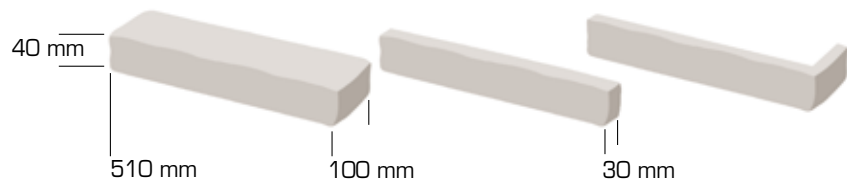

peso mattone • <i>brick weight</i>	± 3,9 Kg
peso listello • <i>brick-slip weight</i>	± 1,20 Kg
pezzi a mq • <i>pieces x sqm</i>	± 37 pcs/m <sup>2</sup>
mattoni per bancale • <i>bricks x pallet</i>	245



Architect: Building Concepts, Waregem

## Grande Réserve W40



Architect Building Concepts, Waregem



Architect Buro 5, Julie Valette, Nanime

# Grande Réserve W41

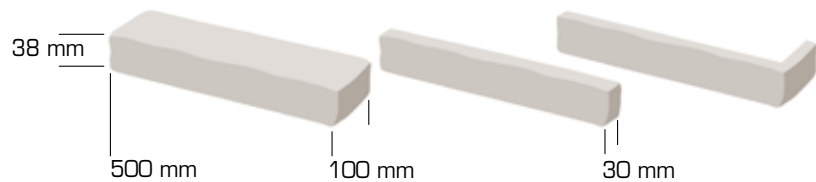

peso mattone • <i>brick weight</i>	± 3,9 Kg
peso listello • <i>brick-slip weight</i>	± 1,20 Kg
pezzi a mq • <i>pieces x sqm</i>	± 39 pcs/m <sup>2</sup>
mattoni per bancale • <i>bricks x pallet</i>	245





Architect KAAAN architecten, Rotterdam

# Grande Réserve W42

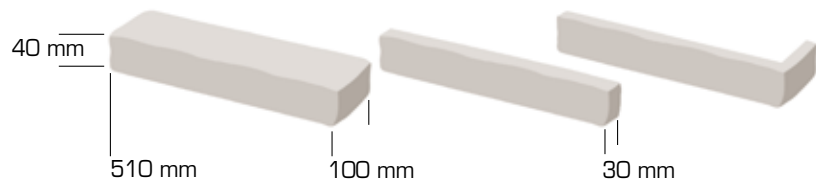

peso mattone • <i>brick weight</i>	± 3,9 Kg
peso listello • <i>brick-slip weight</i>	± 1,20 Kg
pezzi a mq • <i>pieces x sqm</i>	± 37 pcs/m <sup>2</sup>
mattoni per bancale • <i>bricks x pallet</i>	245



Grande Réserve W42





Architect A20 Hasselt, Brussel/Bruxelles

# Grande Réserve W43

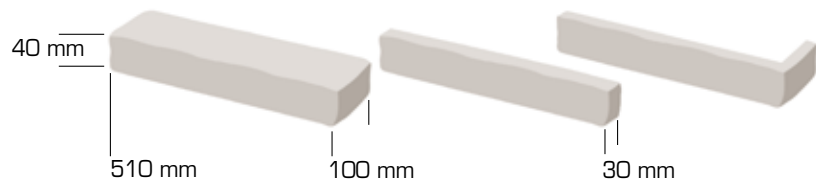

peso mattone • <i>brick weight</i>	± 4,4 Kg
peso listello • <i>brick-slip weight</i>	± 1,30 Kg
pezzi a mq • <i>pieces x sqm</i>	± 37 pcs/m <sup>2</sup>
mattoni per bancale • <i>bricks x pallet</i>	245

180



Architect Benoit Courcelles Architecte, Moulcron

# Grande Réserve W44

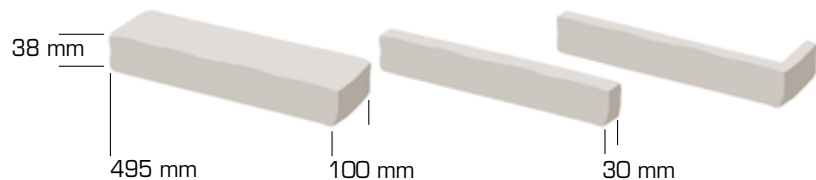

peso mattone • <i>brick weight</i>	± 3,9 Kg
peso listello • <i>brick-slip weight</i>	± 1,20 Kg
pezzi a mq • <i>pieces x sqm</i>	± 40 pcs/m <sup>2</sup>
mattoni per bancale • <i>bricks x pallet</i>	245





# Grande Réserve W45

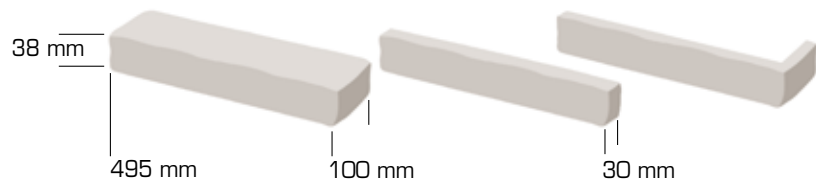

peso mattone • <i>brick weight</i>	± 3,9 Kg
peso listello • <i>brick-slip weight</i>	± 1,20 Kg
pezzi a mq • <i>pieces x sqm</i>	± 40 pcs/m <sup>2</sup>
mattoni per bancale • <i>bricks x pallet</i>	245



Grande Réserve W45



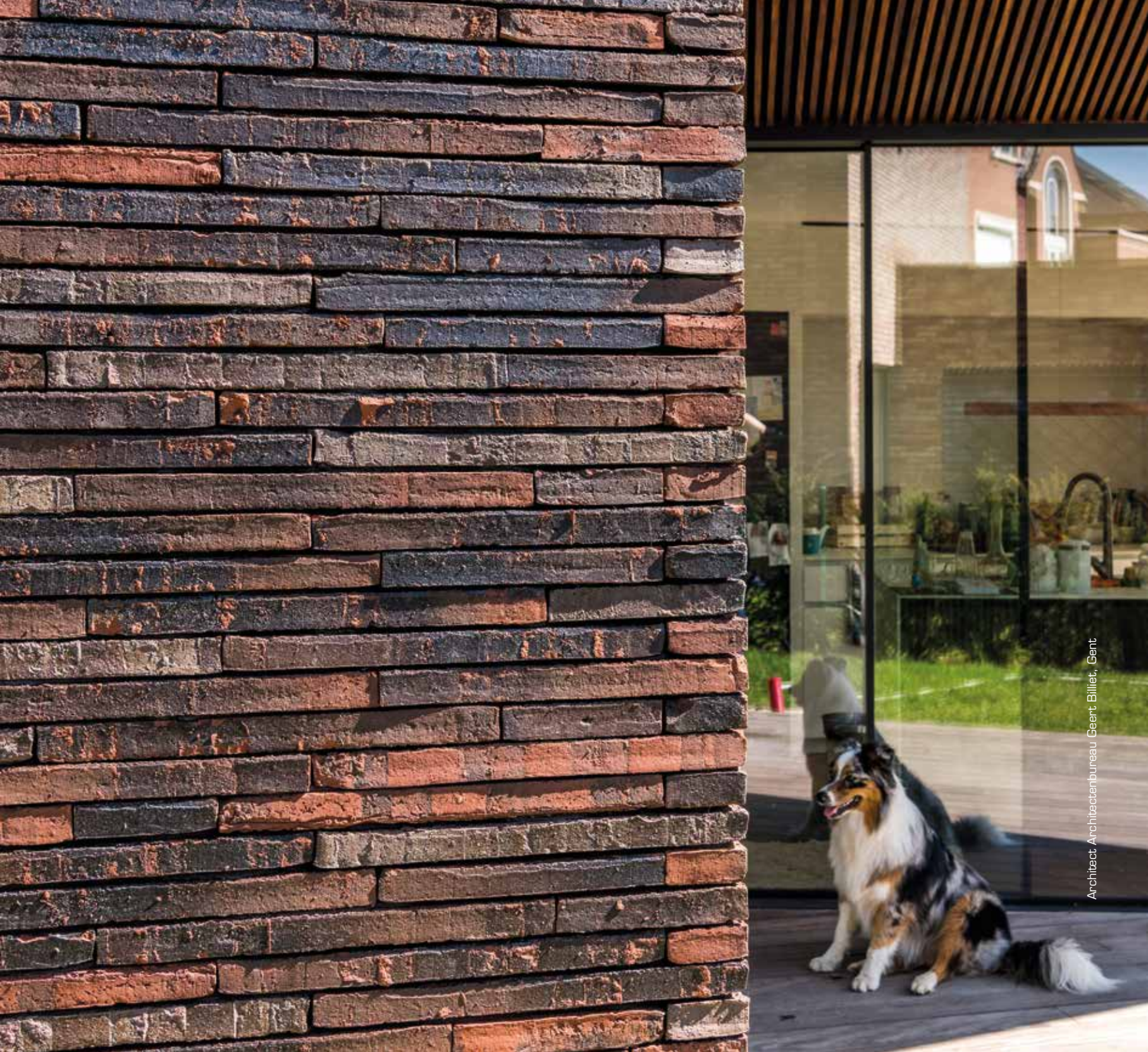

Architect: Architectenbureau Geert Billiet, Gent





Rivestimenti Naturali

Futura

## Listelli da Rivestimento

### **Un capolavoro in soli 14 mm**

Futura è un listello faccia a vista di nuova generazione ottenuto con le più avanzate tecnologie produttive da argille rare selezionate: sottile, molto resistente, ingelivo e leggero, adatto a qualsiasi tipo di applicazione interna o esterna.

### *Facing brick-slips*

### **A work of art in just 14 mm**

*Futura is a new generation facing brick-slip obtained with the most advanced manufacturing technology from rare selected clays: it is thin, very resistant, frost-free and light, suitable for all kinds of indoor or outdoor use.*

# Futura

La leggerezza dei listelli Futura li rende particolarmente adatti per applicazioni su isolamenti a cappotto.

Per tutta la gamma è disponibile l'elemento angolare.

*The Futura brick-slips are so light that they are particularly suitable to be used on exterior insulation systems.*

*The corner shape is available for the whole range.*







# Futura 226

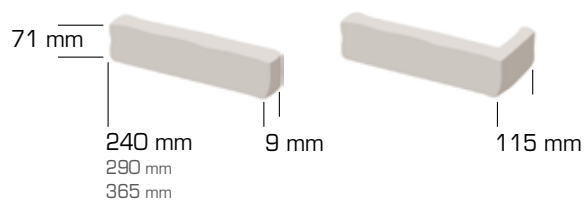
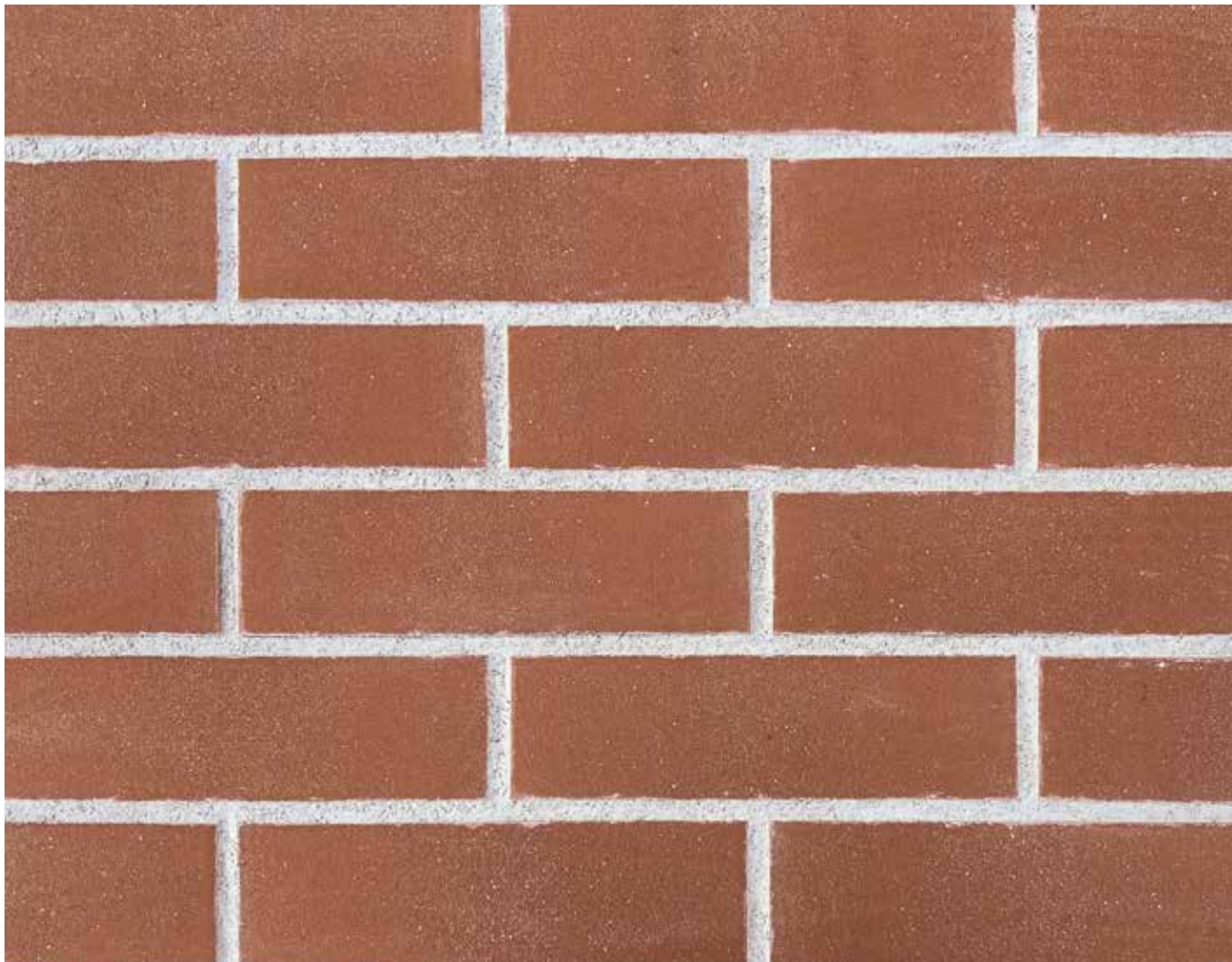

peso listello • <i>brick-slip weight</i>	± 0,35 Kg
pezzi a mq • <i>pieces x sqm</i>	± 48 pcs/m <sup>2</sup>
listelli per scatola • <i>brick-slips x box</i>	48
listelli per bancale • <i>brick-slips x pallet</i>	2.880
angolari per scatola • <i>corners x box</i>	15
angolari per bancale • <i>corners x pallet</i>	1.155

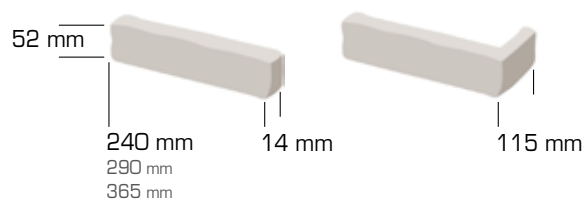
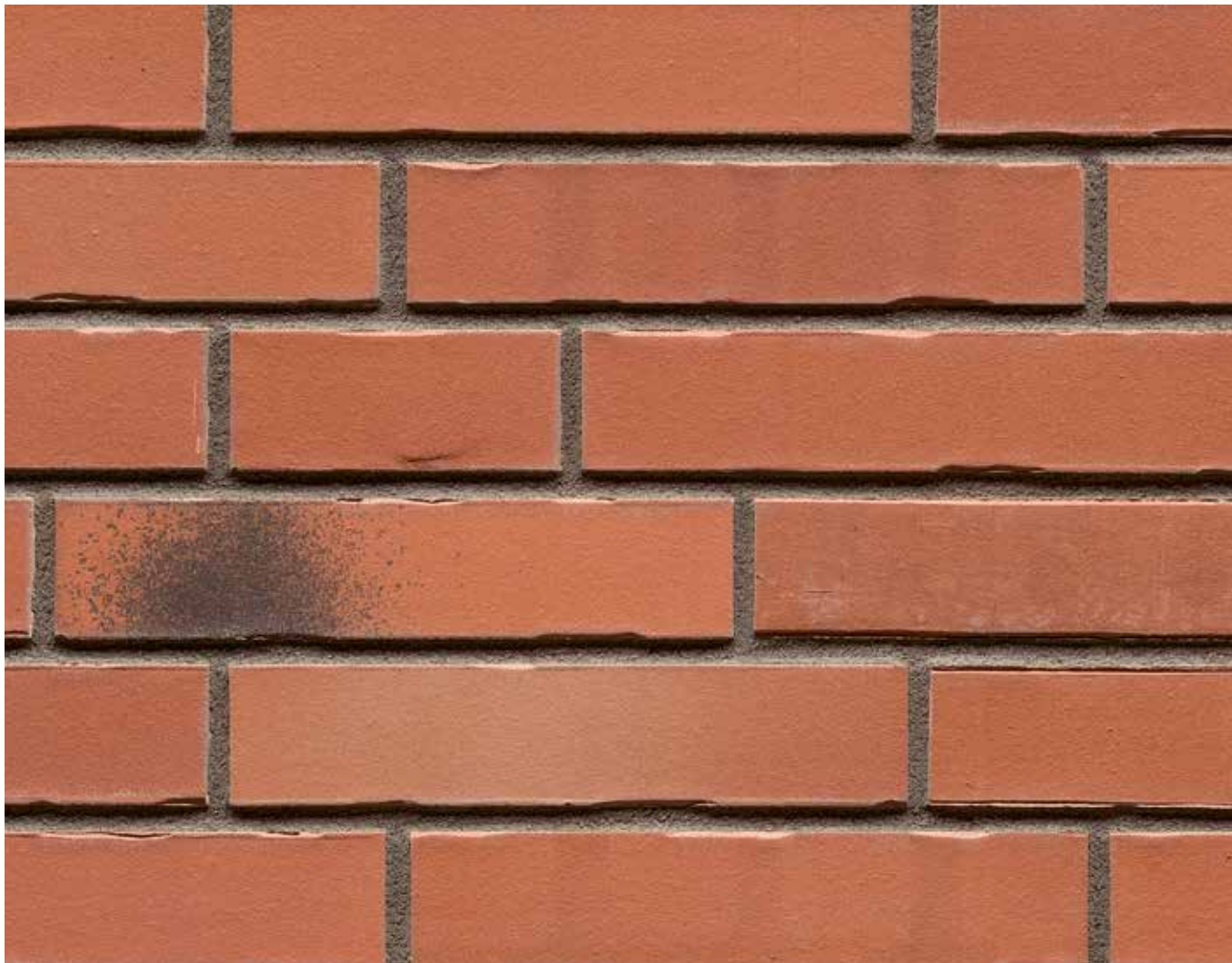

peso listello • <i>brick-slip weight</i>	± 0,37 Kg
pezzi a mq • <i>pieces x sqm</i>	± 64 pcs/m <sup>2</sup>
listelli per scatola • <i>brick-slips x box</i>	32
listelli per bancale • <i>brick-slips x pallet</i>	2.880
angolari per scatola • <i>corners x box</i>	12
angolari per bancale • <i>corners x pallet</i>	1.092

# Futura 757

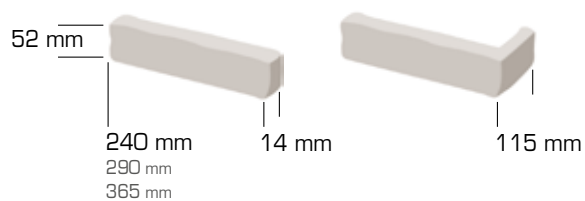

peso listello • <i>brick-slip weight</i>	± 0,37 Kg
pezzi a mq • <i>pieces x sqm</i>	± 64 pcs/m <sup>2</sup>
listelli per scatola • <i>brick-slips x box</i>	32
listelli per bancale • <i>brick-slips x pallet</i>	2.880
angolari per scatola • <i>corners x box</i>	12
angolari per bancale • <i>corners x pallet</i>	1.092



# Futura 764

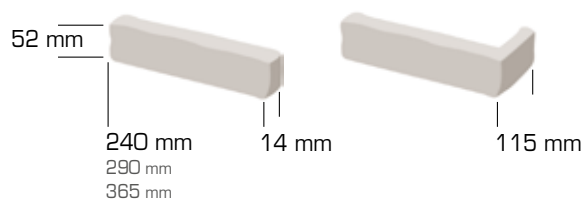

peso listello • <i>brick-slip weight</i>	± 0,37 Kg
pezzi a mq • <i>pieces x sqm</i>	± 64 pcs/m <sup>2</sup>
listelli per scatola • <i>brick-slips x box</i>	32
listelli per bancale • <i>brick-slips x pallet</i>	2.880
angolari per scatola • <i>corners x box</i>	12
angolari per bancale • <i>corners x pallet</i>	1.092



# Futura 991

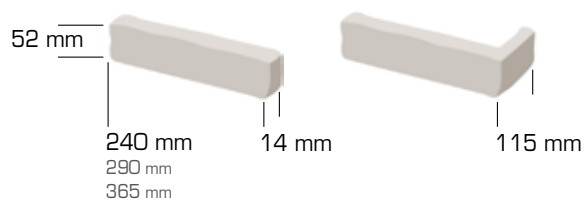

peso listello • <i>brick-slip weight</i>	± 0,37 Kg
pezzi a mq • <i>pieces x sqm</i>	± 64 pcs/m <sup>2</sup>
listelli per scatola • <i>brick-slips x box</i>	32
listelli per bancale • <i>brick-slips x pallet</i>	2.880
angolari per scatola • <i>corners x box</i>	12
angolari per bancale • <i>corners x pallet</i>	1.092





# Futura 737

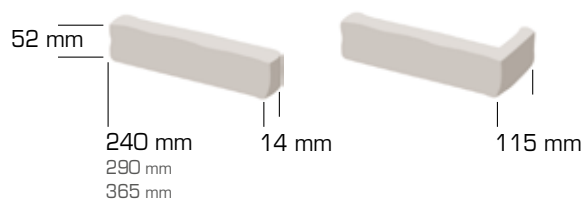

peso listello • <i>brick-slip weight</i>	± 0,37 Kg
pezzi a mq • <i>pieces x sqm</i>	± 64 pcs/m <sup>2</sup>
listelli per scatola • <i>brick-slips x box</i>	32
listelli per bancale • <i>brick-slips x pallet</i>	2.880
angolari per scatola • <i>corners x box</i>	12
angolari per bancale • <i>corners x pallet</i>	1.092



Architekt: Thorsten Schirmer - Foto: Uwe Schmida

# Futura 382

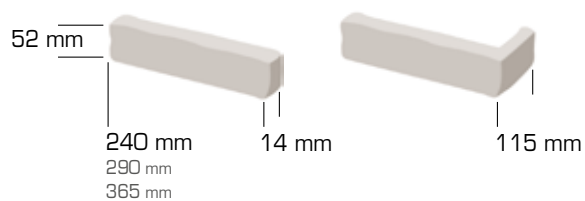

peso listello • <i>brick-slip weight</i>	± 0,37 Kg
pezzi a mq • <i>pieces x sqm</i>	± 64 pcs/m <sup>2</sup>
listelli per scatola • <i>brick-slips x box</i>	32
listelli per bancale • <i>brick-slips x pallet</i>	2.880
angolari per scatola • <i>corners x box</i>	12
angolari per bancale • <i>corners x pallet</i>	1.092

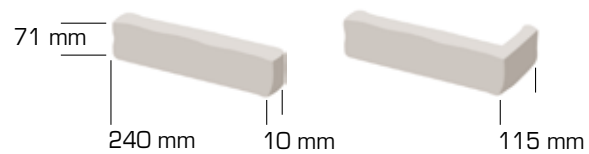

peso listello • <i>brick-slip weight</i>	± 0,39 Kg
pezzi a mq • <i>pieces x sqm</i>	± 48 pcs/m <sup>2</sup>
listelli per scatola • <i>brick-slips x box</i>	48
listelli per bancale • <i>brick-slips x pallet</i>	2.880
angolari per scatola • <i>corners x box</i>	22
angolari per bancale • <i>corners x pallet</i>	924

# Futura 943

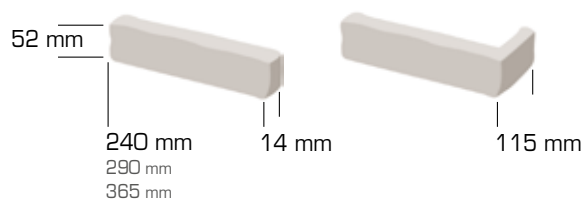

peso listello • <i>brick-slip weight</i>	± 0,37 Kg
pezzi a mq • <i>pieces x sqm</i>	± 64 pcs/m <sup>2</sup>
listelli per scatola • <i>brick-slips x box</i>	32
listelli per bancale • <i>brick-slips x pallet</i>	2.880
angolari per scatola • <i>corners x box</i>	12
angolari per bancale • <i>corners x pallet</i>	1.092



# Futura 945

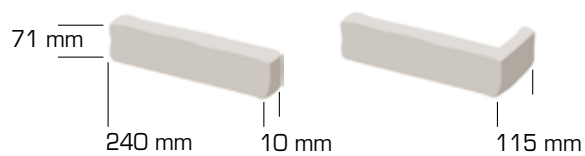
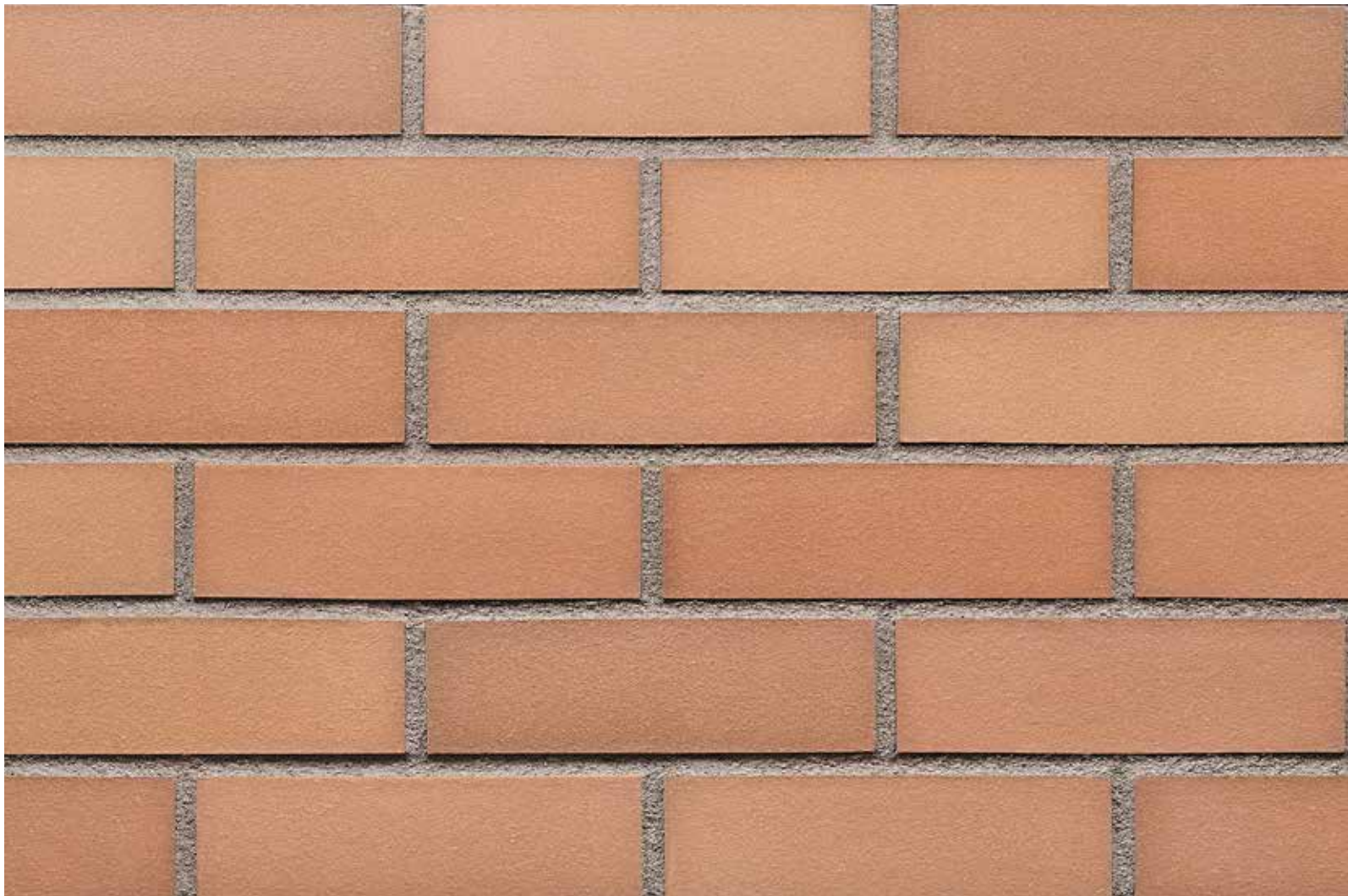

peso listello • <i>brick-slip weight</i>	± 0,41 Kg
pezzi a mq • <i>pieces x sqm</i>	± 48 pcs/m <sup>2</sup>
listelli per scatola • <i>brick-slips x box</i>	48
listelli per bancale • <i>brick-slips x pallet</i>	2.880
angolari per scatola • <i>corners x box</i>	22
angolari per bancale • <i>corners x pallet</i>	924





# Futura 505

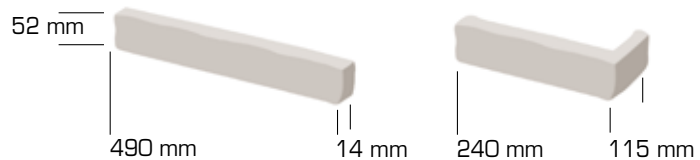

peso listello • <i>brick-slip weight</i>	± 0,85 Kg
pezzi a mq • <i>pieces x sqm</i>	± 31 pcs/m <sup>2</sup>
listelli per scatola • <i>brick-slips x box</i>	16
listelli per bancale • <i>brick-slips x pallet</i>	1.232
angolari per scatola • <i>corners x box</i>	18
angolari per bancale • <i>corners x pallet</i>	972



# Futura 507

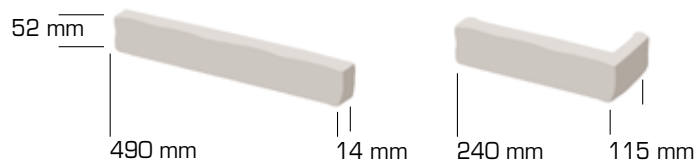

peso listello • <i>brick-slip weight</i>	± 0,85 Kg
pezzi a mq • <i>pieces x sqm</i>	± 31 pcs/m <sup>2</sup>
listelli per scatola • <i>brick-slips x box</i>	16
listelli per bancale • <i>brick-slips x pallet</i>	1.232
angolari per scatola • <i>corners x box</i>	18
angolari per bancale • <i>corners x pallet</i>	972

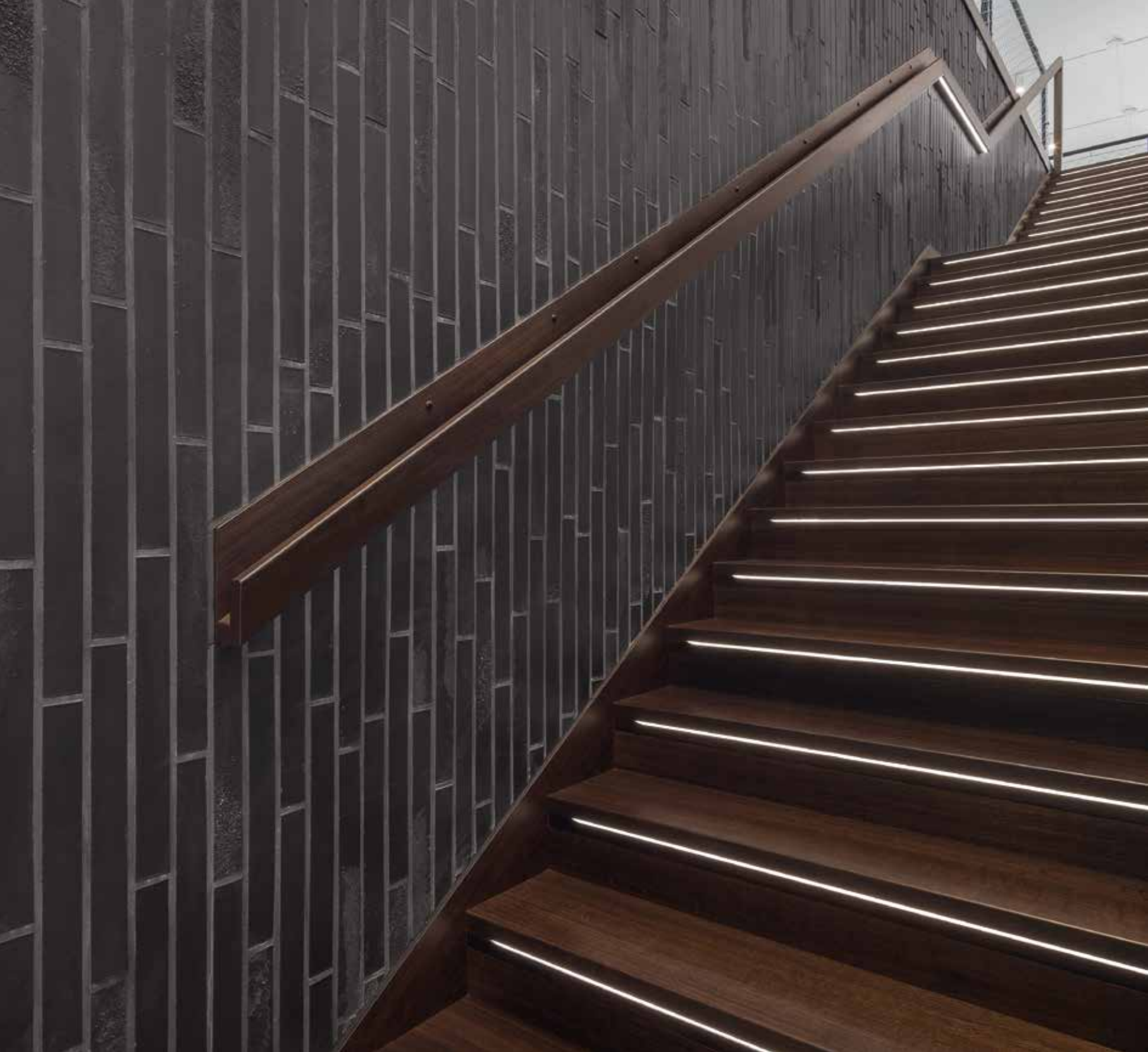





Rivestimenti Naturali

Croma

## Mattoni e listelli smaltati

### Un fascino moderno

B&B presenta una straordinaria serie di mattoni e listelli smaltati in sintonia con la propria filosofia sensibile ai materiali naturali, di pregio e di elevato valore estetico. Si tratta di mattoni di prima qualità ad alte prestazioni: resistenti al gelo, di elevata inerzia termica, con una smaltatura dal colore inalterabile nel tempo ed estremamente resistente. Disponibili in tutta la gamma colori RAL, con finitura liscia o ruvida, sono adatti a tutte le esigenze architettoniche, per esterni e per interni, perfetti per creare originalità in qualsiasi contesto, classico o moderno. Ideali per il rivestimento di grandi superfici, molto versatili per interventi contenuti, utilizzabili anche nelle pavimentazioni. Insomma, nessun limite alla fantasia!

### *Glazed bricks and brick-slips*

#### **A modern charm**

*B&B presents an extraordinary series of glazed bricks and brick-slips in tune with its philosophy sensitive to natural and precious materials of high aesthetic value. These are first class and high performance bricks: frost resistant, high thermal inertia, with a glazing having a permanent colour and extremely resistant over the time. Available in the whole RAL colour range, with smooth or rough finishing, they are suitable for any architectural requirement, for exteriors or interiors, perfect to create novelty in any context, either classic or modern. Ideal to cover wide surfaces, very versatile for moderate interventions, usable also for floorings. In other words, no limits to fantasy!*



## Caratteristiche tecniche

*Technical specifications*

Resistenza a compressione <i>Compressive strength</i>	<b><math>\geq 100 \text{ N/mm}^2</math></b>
Assorbimento d'acqua <i>Water absorption</i>	<b><math>\leq 5 \%</math></b>
Conducibilità termica <i>Equivalent thermal conductivity</i>	<b><math>0.54 \text{ W/m.K} [\lambda_{10, \text{dry}}]</math></b>



# Croma

## **Mattoni, listello e angolare formato standard**

*Brick, brick-slip and corner standard format*



48 x 220 x 25 mm

48 x 220 x 105 mm

Formati a richiesta per quantitativi superiori a 400 m<sup>2</sup>  
*Formats on demand for quantities larger than 400 m<sup>2</sup>*

65 x 215 x 102

48 x 280 x 135

57 x 184 x 92



**Ruvido**  
*Rough*



**Liscio**  
*Smooth*

# 2

## **Due Finiture infinite soluzioni**

Tutta la gamma colori è disponibile nelle due finiture liscia o ruvida. La combinazione tra colori e finiture, insieme alla possibilità di miscelare entrambe le caratteristiche nell'utilizzo, consente una disponibilità di soluzioni davvero impressionante tanto da permetterci l'uso della parola "infinite". L'architetto o il progettista che ne farà uso creativo potrà realizzare opere davvero uniche. Nelle pagine a seguire presentiamo molti esempi di realizzazioni con utilizzo classico del mattone smaltato ma anche realizzazioni innovative che sfruttano le grandi possibilità compositive che questo prodotto offre.

## ***Two Finishings infinite solutions***

*The whole colour range is available in both smooth and rough finishings. The mix of colours and finishings along with the possibility to combine both characteristics in the use, allows a really striking availability of solutions such to permit the use of the word "infinite". The architect or the designer that will use them in a creative way can realize really unique works. In the following pages we present a lot of examples of realizations with classic use of the glazed brick but also innovative realizations using the great possibilities of composition that this product offers.*

# Croma 11

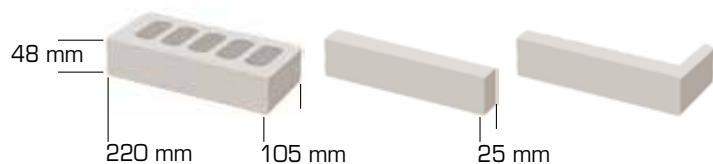

peso mattone • <i>brick weight</i>	± 1,72 Kg
peso listello • <i>brick-slip weight</i>	± 0,52 Kg
pezzi a mq • <i>pieces x sqm</i>	± 75 pcs/m <sup>2</sup>
mattoni per bancale • <i>bricks x pallet</i>	312
listelli per scatola • <i>brick-slips x box</i>	36
listelli per bancale • <i>brick-slips x pallet</i>	1125
angolari per scatola • <i>corners x box</i>	15
angolari per bancale • <i>corners x pallet</i>	650



# Croma 12

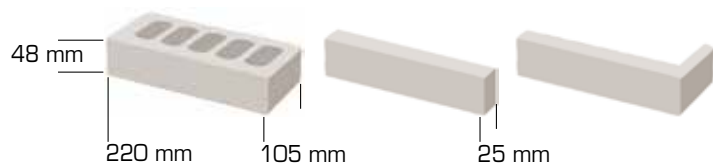
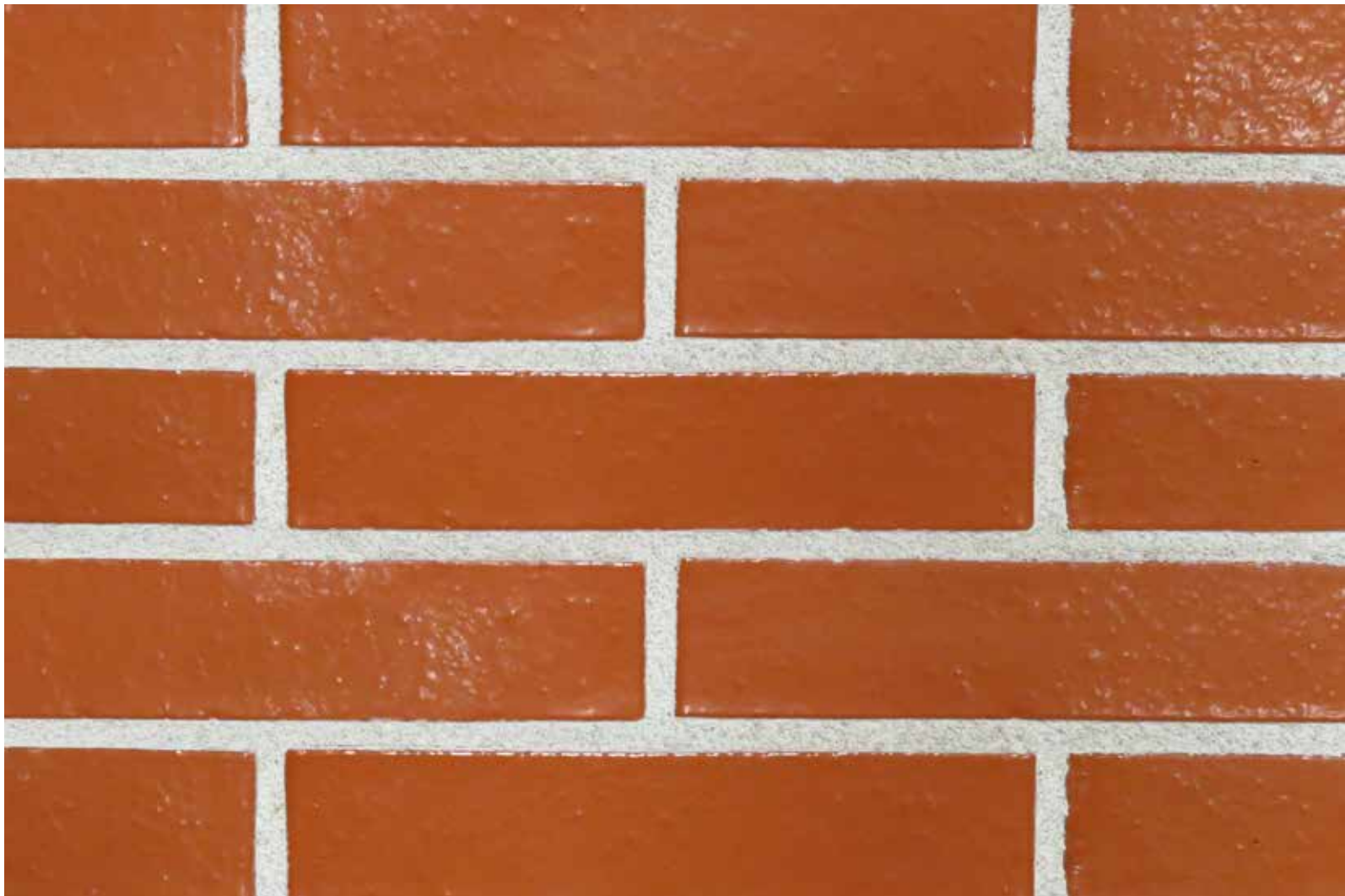

peso mattone • <i>brick weight</i>	± 1,72 Kg
peso listello • <i>brick-slip weight</i>	± 0,52 Kg
pezzi a mq • <i>pieces x sqm</i>	± 75 pcs/m <sup>2</sup>
mattoni per bancale • <i>bricks x pallet</i>	312
listelli per scatola • <i>brick-slips x box</i>	36
listelli per bancale • <i>brick-slips x pallet</i>	1125
angolari per scatola • <i>corners x box</i>	15
angolari per bancale • <i>corners x pallet</i>	650



# Croma 13

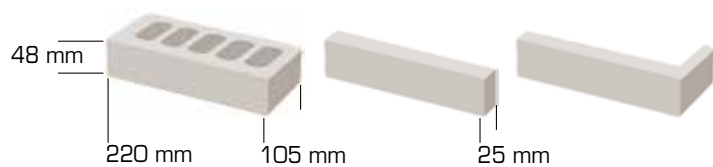
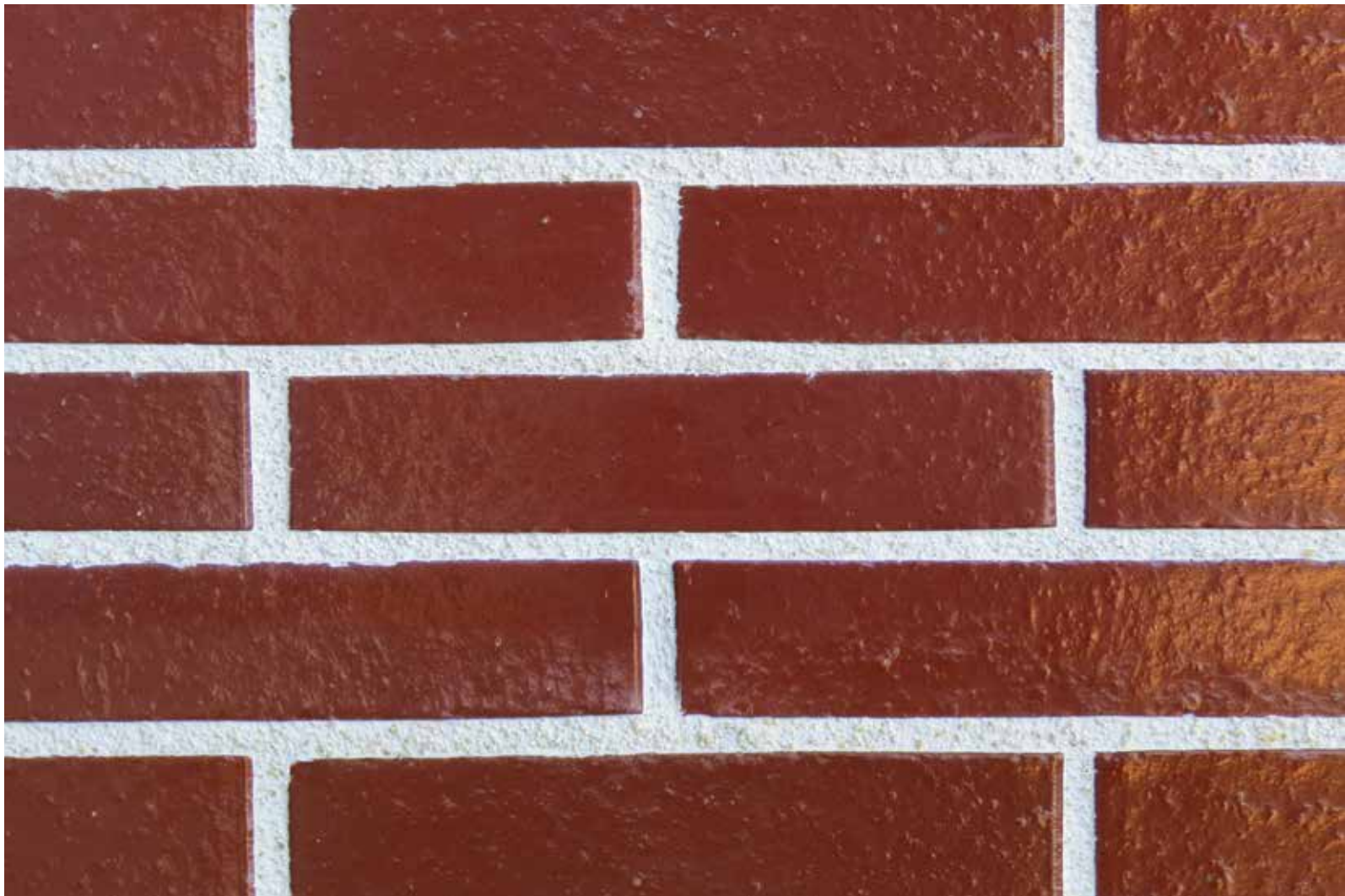

peso mattone • <i>brick weight</i>	± 1,72 Kg
peso listello • <i>brick-slip weight</i>	± 0,52 Kg
pezzi a mq • <i>pieces x sqm</i>	± 75 pcs/m <sup>2</sup>
mattoni per bancale • <i>bricks x pallet</i>	312
listelli per scatola • <i>brick-slips x box</i>	36
listelli per bancale • <i>brick-slips x pallet</i>	1125
angolari per scatola • <i>corners x box</i>	15
angolari per bancale • <i>corners x pallet</i>	650





# Croma 14

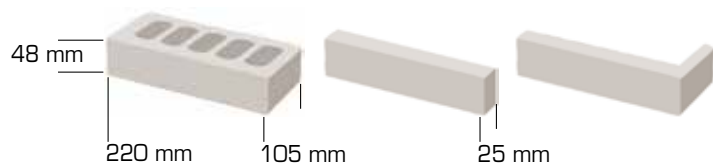

peso mattone • <i>brick weight</i>	± 1,72 Kg
peso listello • <i>brick-slip weight</i>	± 0,52 Kg
pezzi a mq • <i>pieces x sqm</i>	± 75 pcs/m <sup>2</sup>
mattoni per bancale • <i>bricks x pallet</i>	312
listelli per scatola • <i>brick-slips x box</i>	36
listelli per bancale • <i>brick-slips x pallet</i>	1125
angolari per scatola • <i>corners x box</i>	15
angolari per bancale • <i>corners x pallet</i>	650



# Croma 15

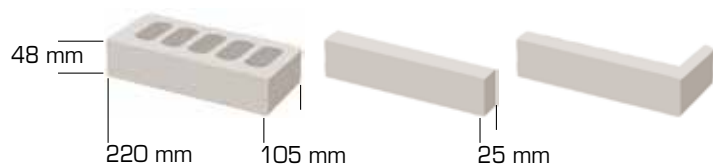

peso mattone • <i>brick weight</i>	± 1,72 Kg
peso listello • <i>brick-slip weight</i>	± 0,52 Kg
pezzi a mq • <i>pieces x sqm</i>	± 75 pcs/m <sup>2</sup>
mattoni per bancale • <i>bricks x pallet</i>	312
listelli per scatola • <i>brick-slips x box</i>	36
listelli per bancale • <i>brick-slips x pallet</i>	1125
angolari per scatola • <i>corners x box</i>	15
angolari per bancale • <i>corners x pallet</i>	650



# Croma 21

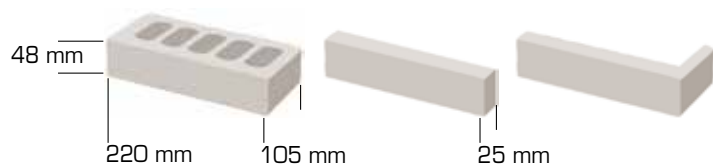

peso mattone • <i>brick weight</i>	± 1,72 Kg
peso listello • <i>brick-slip weight</i>	± 0,52 Kg
pezzi a mq • <i>pieces x sqm</i>	± 75 pcs/m <sup>2</sup>
mattoni per bancale • <i>bricks x pallet</i>	312
listelli per scatola • <i>brick-slips x box</i>	36
listelli per bancale • <i>brick-slips x pallet</i>	1125
angolari per scatola • <i>corners x box</i>	15
angolari per bancale • <i>corners x pallet</i>	650



## Croma 22

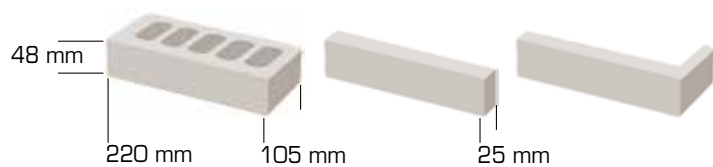

peso mattone • <i>brick weight</i>	± 1,72 Kg
peso listello • <i>brick-slip weight</i>	± 0,52 Kg
pezzi a mq • <i>pieces x sqm</i>	± 75 pcs/m <sup>2</sup>
mattoni per bancale • <i>bricks x pallet</i>	312
listelli per scatola • <i>brick-slips x box</i>	36
listelli per bancale • <i>brick-slips x pallet</i>	1125
angolari per scatola • <i>corners x box</i>	15
angolari per bancale • <i>corners x pallet</i>	650





# Croma 23

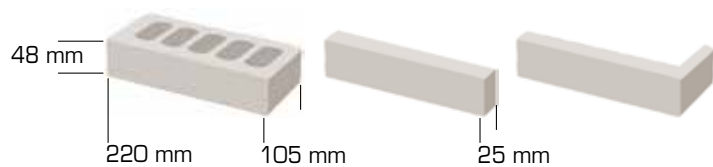

peso mattone • <i>brick weight</i>	± 1,72 Kg
peso listello • <i>brick-slip weight</i>	± 0,52 Kg
pezzi a mq • <i>pieces x sqm</i>	± 75 pcs/m <sup>2</sup>
mattoni per bancale • <i>bricks x pallet</i>	312
listelli per scatola • <i>brick-slips x box</i>	36
listelli per bancale • <i>brick-slips x pallet</i>	1125
angolari per scatola • <i>corners x box</i>	15
angolari per bancale • <i>corners x pallet</i>	650



# Croma 24

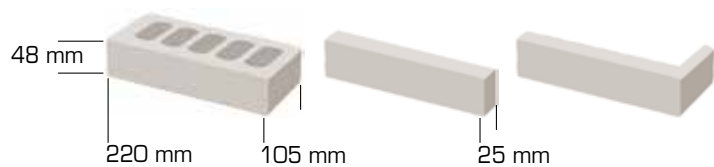

peso mattone • <i>brick weight</i>	± 1,72 Kg
peso listello • <i>brick-slip weight</i>	± 0,52 Kg
pezzi a mq • <i>pieces x sqm</i>	± 75 pcs/m <sup>2</sup>
mattoni per bancale • <i>bricks x pallet</i>	312
listelli per scatola • <i>brick-slips x box</i>	36
listelli per bancale • <i>brick-slips x pallet</i>	1125
angolari per scatola • <i>corners x box</i>	15
angolari per bancale • <i>corners x pallet</i>	650



# Croma 25

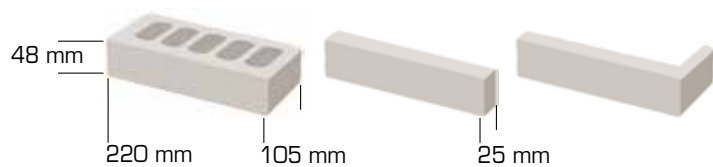

peso mattone • <i>brick weight</i>	± 1,72 Kg
peso listello • <i>brick-slip weight</i>	± 0,52 Kg
pezzi a mq • <i>pieces x sqm</i>	± 75 pcs/m <sup>2</sup>
mattoni per bancale • <i>bricks x pallet</i>	312
listelli per scatola • <i>brick-slips x box</i>	36
listelli per bancale • <i>brick-slips x pallet</i>	1125
angolari per scatola • <i>corners x box</i>	15
angolari per bancale • <i>corners x pallet</i>	650



# Croma 31

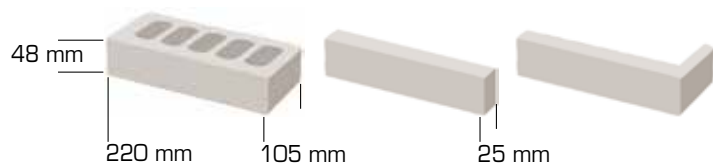

peso mattone • <i>brick weight</i>	± 1,72 Kg
peso listello • <i>brick-slip weight</i>	± 0,52 Kg
pezzi a mq • <i>pieces x sqm</i>	± 75 pcs/m <sup>2</sup>
mattoni per bancale • <i>bricks x pallet</i>	312
listelli per scatola • <i>brick-slips x box</i>	36
listelli per bancale • <i>brick-slips x pallet</i>	1125
angolari per scatola • <i>corners x box</i>	15
angolari per bancale • <i>corners x pallet</i>	650





Croma 31









# Croma 32

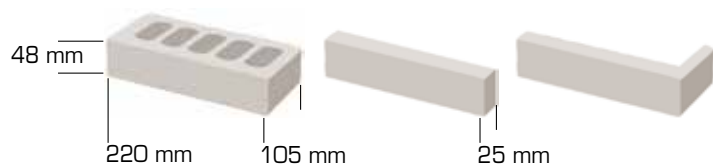

peso mattone • <i>brick weight</i>	± 1,72 Kg
peso listello • <i>brick-slip weight</i>	± 0,52 Kg
pezzi a mq • <i>pieces x sqm</i>	± 75 pcs/m <sup>2</sup>
mattoni per bancale • <i>bricks x pallet</i>	312
listelli per scatola • <i>brick-slips x box</i>	36
listelli per bancale • <i>brick-slips x pallet</i>	1125
angolari per scatola • <i>corners x box</i>	15
angolari per bancale • <i>corners x pallet</i>	650

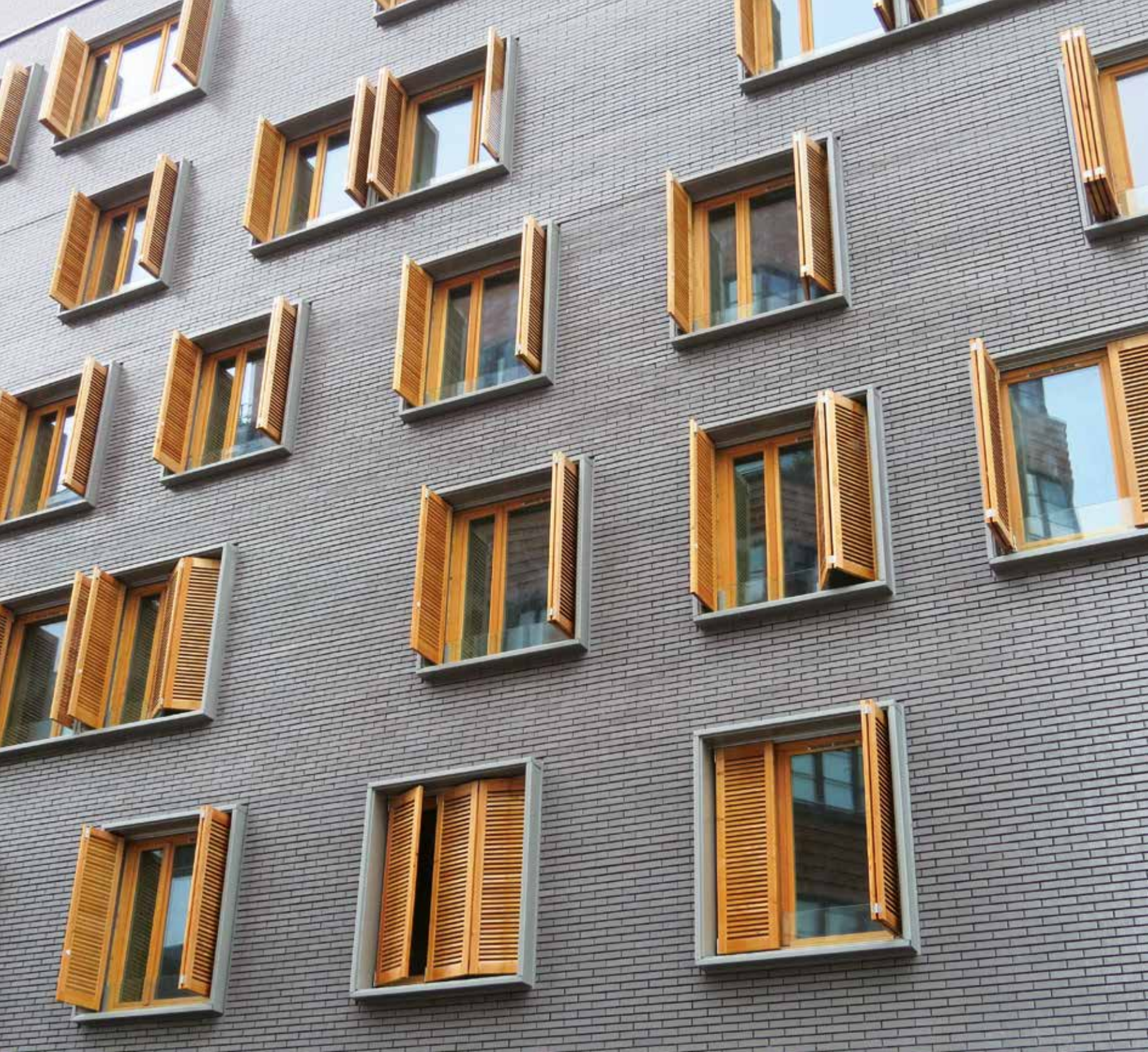

Croma 32







Croma 32





# Croma 33

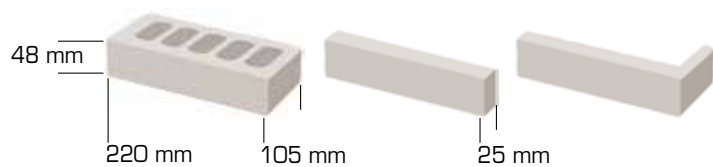

peso mattone • <i>brick weight</i>	± 1,72 Kg
peso listello • <i>brick-slip weight</i>	± 0,52 Kg
pezzi a mq • <i>pieces x sqm</i>	± 75 pcs/m²
mattoni per bancale • <i>bricks x pallet</i>	312
listelli per scatola • <i>brick-slips x box</i>	36
listelli per bancale • <i>brick-slips x pallet</i>	1125
angolari per scatola • <i>corners x box</i>	15
angolari per bancale • <i>corners x pallet</i>	650







Croma 33







# Croma 41

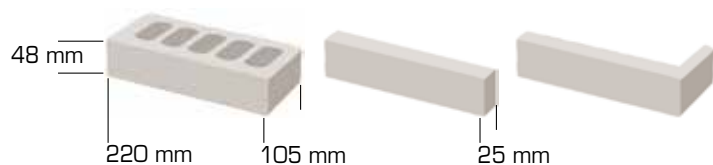

peso mattone • <i>brick weight</i>	± 1,72 Kg
peso listello • <i>brick-slip weight</i>	± 0,52 Kg
pezzi a mq • <i>pieces x sqm</i>	± 75 pcs/m <sup>2</sup>
mattoni per bancale • <i>bricks x pallet</i>	312
listelli per scatola • <i>brick-slips x box</i>	36
listelli per bancale • <i>brick-slips x pallet</i>	1125
angolari per scatola • <i>corners x box</i>	15
angolari per bancale • <i>corners x pallet</i>	650



# Croma 42

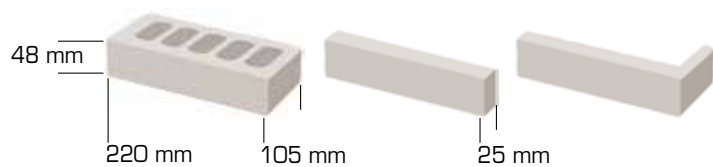

peso mattone • <i>brick weight</i>	± 1,72 Kg
peso listello • <i>brick-slip weight</i>	± 0,52 Kg
pezzi a mq • <i>pieces x sqm</i>	± 75 pcs/m <sup>2</sup>
mattoni per bancale • <i>bricks x pallet</i>	312
listelli per scatola • <i>brick-slips x box</i>	36
listelli per bancale • <i>brick-slips x pallet</i>	1125
angolari per scatola • <i>corners x box</i>	15
angolari per bancale • <i>corners x pallet</i>	650







# Croma 71

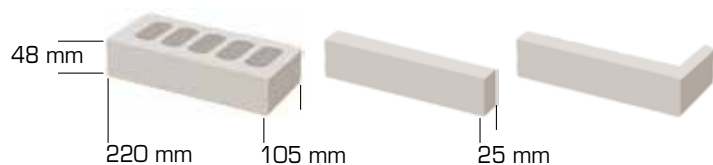

peso mattone • <i>brick weight</i>	± 1,72 Kg
peso listello • <i>brick-slip weight</i>	± 0,52 Kg
pezzi a mq • <i>pieces x sqm</i>	± 75 pcs/m <sup>2</sup>
mattoni per bancale • <i>bricks x pallet</i>	312
listelli per scatola • <i>brick-slips x box</i>	36
listelli per bancale • <i>brick-slips x pallet</i>	1125
angolari per scatola • <i>corners x box</i>	15
angolari per bancale • <i>corners x pallet</i>	650





# Croma 72

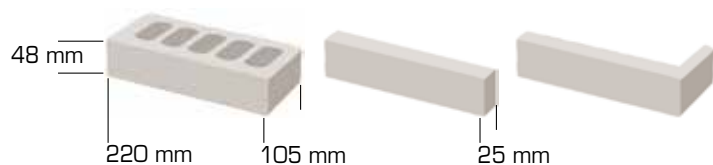

peso mattone • <i>brick weight</i>	± 1,72 Kg
peso listello • <i>brick-slip weight</i>	± 0,52 Kg
pezzi a mq • <i>pieces x sqm</i>	± 75 pcs/m <sup>2</sup>
mattoni per bancale • <i>bricks x pallet</i>	312
listelli per scatola • <i>brick-slips x box</i>	36
listelli per bancale • <i>brick-slips x pallet</i>	1125
angolari per scatola • <i>corners x box</i>	15
angolari per bancale • <i>corners x pallet</i>	650







# Croma 73

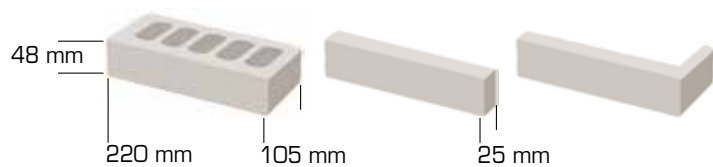
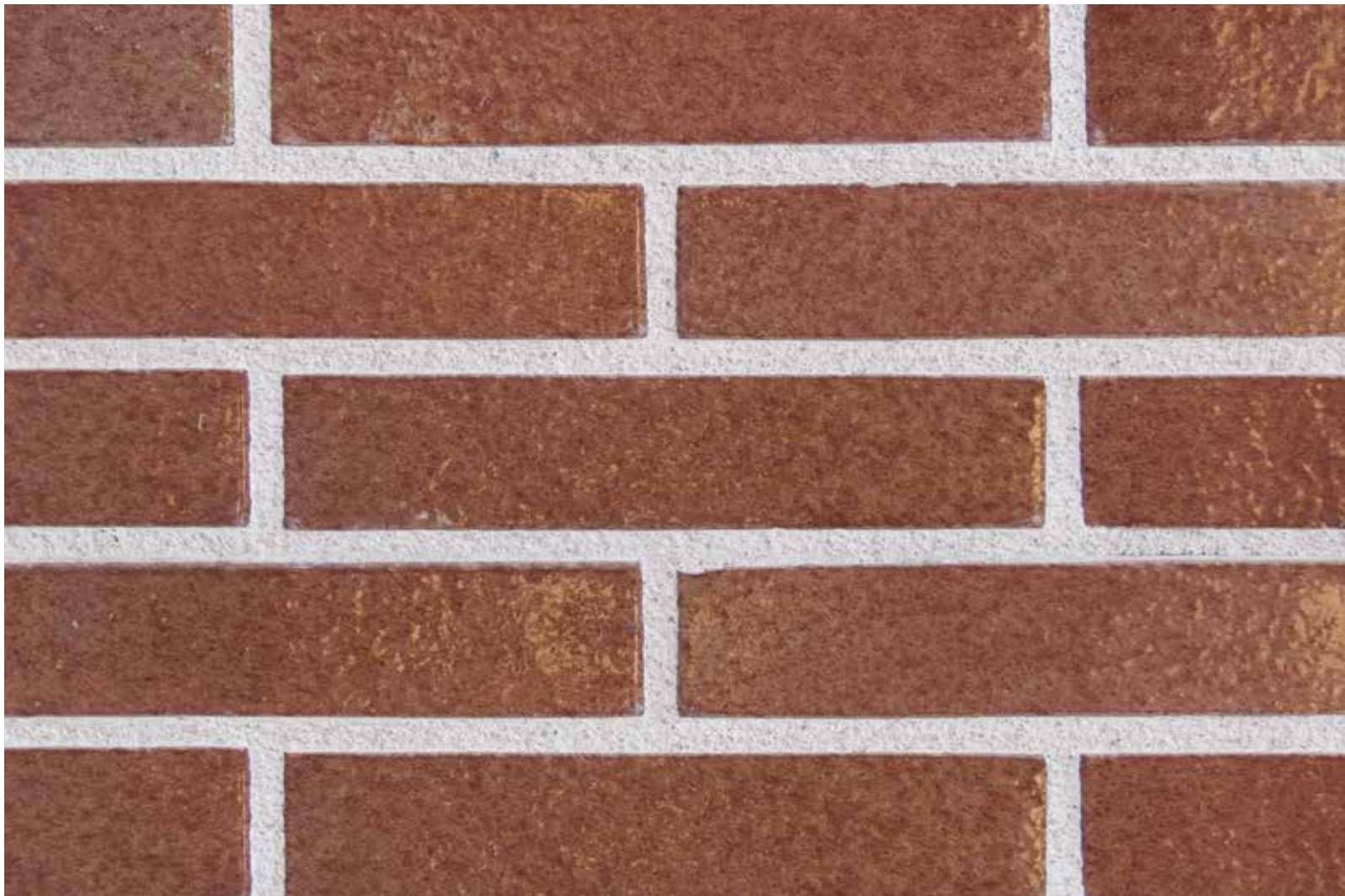

peso mattone • <i>brick weight</i>	± 1,72 Kg
peso listello • <i>brick-slip weight</i>	± 0,52 Kg
pezzi a mq • <i>pieces x sqm</i>	± 75 pcs/m <sup>2</sup>
mattoni per bancale • <i>bricks x pallet</i>	312
listelli per scatola • <i>brick-slips x box</i>	36
listelli per bancale • <i>brick-slips x pallet</i>	1125
angolari per scatola • <i>corners x box</i>	15
angolari per bancale • <i>corners x pallet</i>	650



# Croma 74

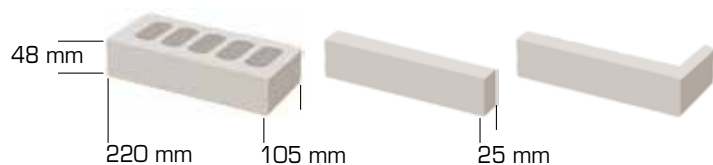

peso mattone • <i>brick weight</i>	± 1,72 Kg
peso listello • <i>brick-slip weight</i>	± 0,52 Kg
pezzi a mq • <i>pieces x sqm</i>	± 75 pcs/m <sup>2</sup>
mattoni per bancale • <i>bricks x pallet</i>	312
listelli per scatola • <i>brick-slips x box</i>	36
listelli per bancale • <i>brick-slips x pallet</i>	1125
angolari per scatola • <i>corners x box</i>	15
angolari per bancale • <i>corners x pallet</i>	650





52





# Croma 75

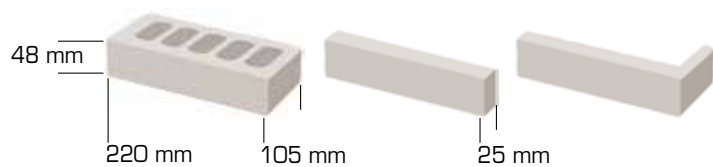

peso mattone • <i>brick weight</i>	± 1,72 Kg
peso listello • <i>brick-slip weight</i>	± 0,52 Kg
pezzi a mq • <i>pieces x sqm</i>	± 75 pcs/m <sup>2</sup>
mattoni per bancale • <i>bricks x pallet</i>	312
listelli per scatola • <i>brick-slips x box</i>	36
listelli per bancale • <i>brick-slips x pallet</i>	1125
angolari per scatola • <i>corners x box</i>	15
angolari per bancale • <i>corners x pallet</i>	650







# Croma 91

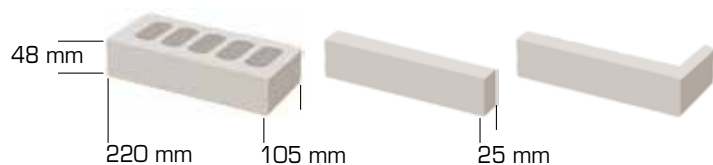

peso mattone • <i>brick weight</i>	± 1,72 Kg
peso listello • <i>brick-slip weight</i>	± 0,52 Kg
pezzi a mq • <i>pieces x sqm</i>	± 95 pcs/m <sup>2</sup>
mattoni per bancale • <i>bricks x pallet</i>	312
listelli per scatola • <i>brick-slips x box</i>	36
listelli per bancale • <i>brick-slips x pallet</i>	1125
angolari per scatola • <i>corners x box</i>	15
angolari per bancale • <i>corners x pallet</i>	650





peso mattone • <i>brick weight</i>	± 1,72 Kg
peso listello • <i>brick-slip weight</i>	± 0,52 Kg
pezzi a mq • <i>pieces x sqm</i>	± 95 pcs/m <sup>2</sup>
mattoni per bancale • <i>bricks x pallet</i>	312
listelli per scatola • <i>brick-slips x box</i>	36
listelli per bancale • <i>brick-slips x pallet</i>	1125
angolari per scatola • <i>corners x box</i>	15
angolari per bancale • <i>corners x pallet</i>	650

# Croma 93

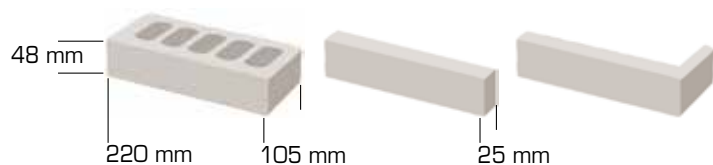

peso mattone • <i>brick weight</i>	± 1,72 Kg
peso listello • <i>brick-slip weight</i>	± 0,52 Kg
pezzi a mq • <i>pieces x sqm</i>	± 95 pcs/m²
mattoni per bancale • <i>bricks x pallet</i>	312
listelli per scatola • <i>brick-slips x box</i>	36
listelli per bancale • <i>brick-slips x pallet</i>	1125
angolari per scatola • <i>corners x box</i>	15
angolari per bancale • <i>corners x pallet</i>	650





**TUTTI  
I COLORI RAL**

sono disponibili su ordinazione  
per quantità superiori a 400 m<sup>2</sup>

***ALL RAL COLOURS***

*are available to order  
for quantities larger  
than 400 m<sup>2</sup>*

# 2



## **Bicolore**

### **Mattoni per effetti speciali**

Per ampliare le possibilità compositive vi proponiamo una colorazione speciale: un mattone con le facce adiacenti smaltate con due colori differenti, quelli che sceglierete.

Questo consente di realizzare due pareti diverse che si incontrano in uno spigolo perfetto o altri effetti particolari.

## ***Two-tone***

### ***Bricks for special effects***

*In order to increase the possibilities of composition we propose a special colouring: a brick with adjacent glazed faces with two different colours, those chosen by you.*

*This allows to realize two different walls that meet themselves in a perfect corner or other particular effects.*





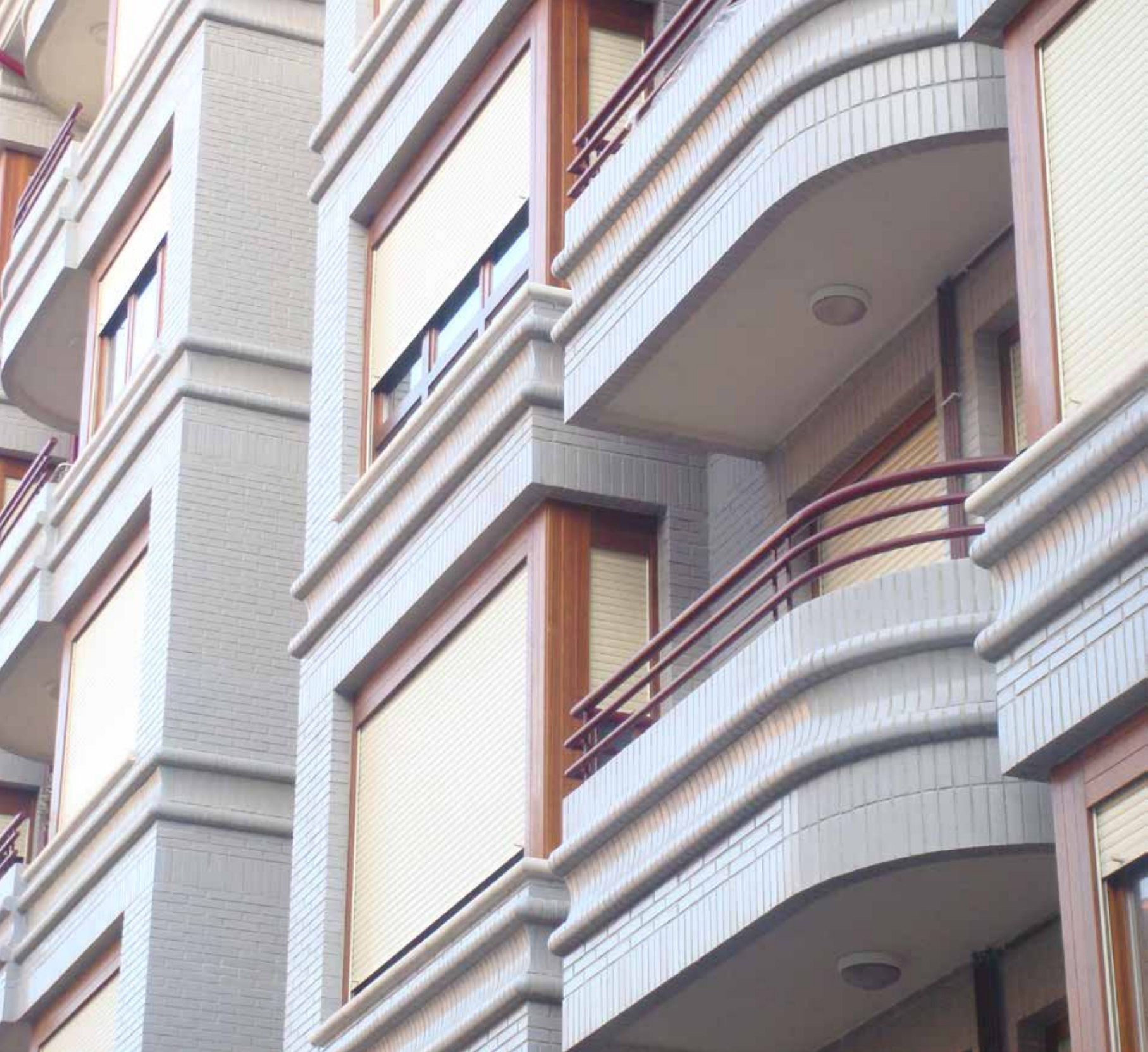





## **Pezzi speciali**

Per completare la gamma dei mattoni e listelli smaltati, proponiamo una serie di pezzi speciali adatti per tutte quelle finiture che in fase di progetto si potranno inserire mantenendo una perfetta continuità con le superfici smaltate.

## ***Special pieces***

*In order to complete the range of glazed bricks and brick-slips, we propose a set of special pieces suitable for all those finishings that during the design phase can be inserted maintaining a perfect continuity with the glazed surfaces.*

## Forme speciali • *Special shapes*

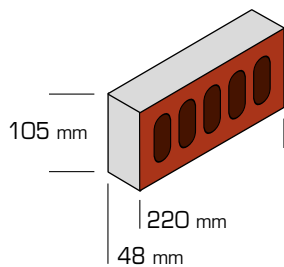

Croma SP **01**

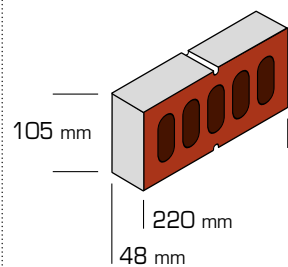

Croma SP **02**

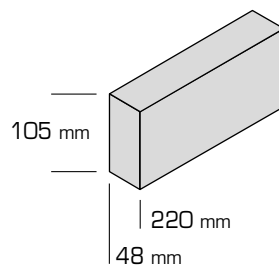

Croma SP **03**

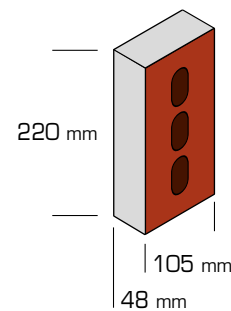

Croma SP **05**

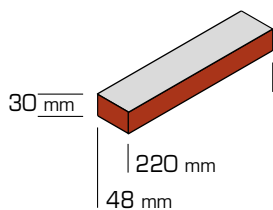

Croma SP **07**

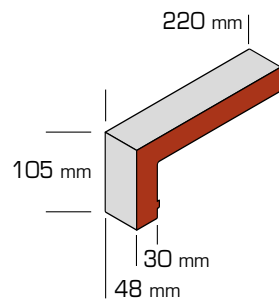

Croma SP **09**

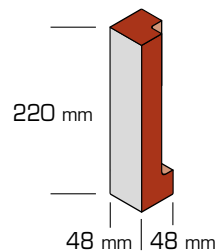

Croma SP **11**

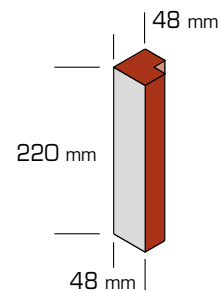

Croma SP **13**

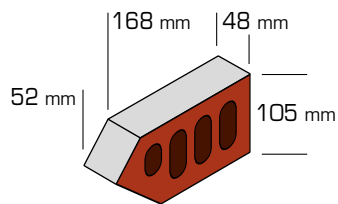

Croma SP **15**

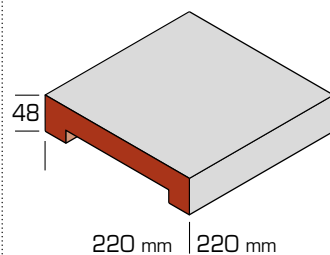

Croma SP **19**

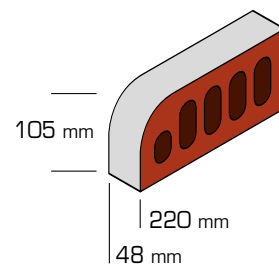

Croma SP **35**

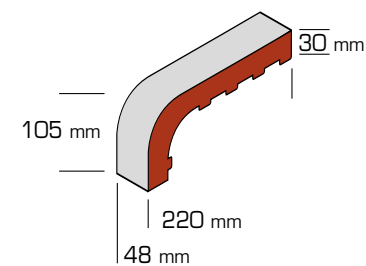

Croma SP **37**

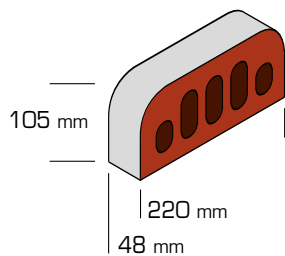

Croma SP **39**

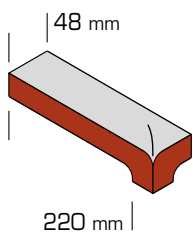

Croma SP **41**

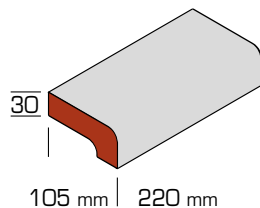

Croma SP **48**

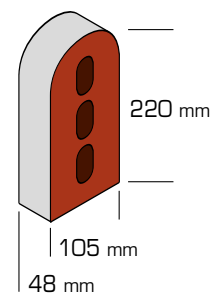

Croma SP **50**

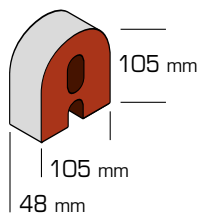

Croma SP **51**

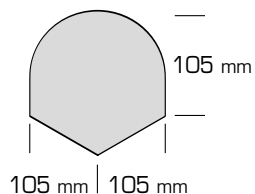

Croma SP **60**

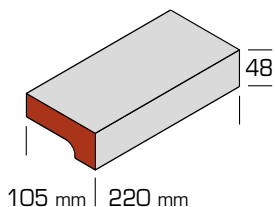

Croma SP **66**

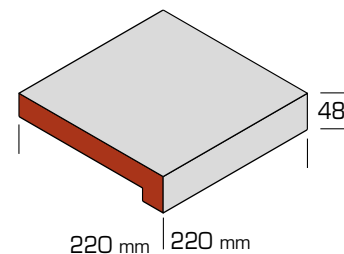

Croma SP **93**

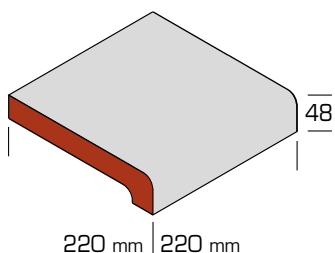

Croma SP **116**

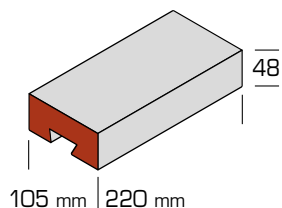

Croma SP **125**

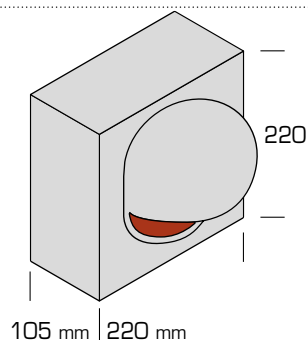

Croma SP **128**

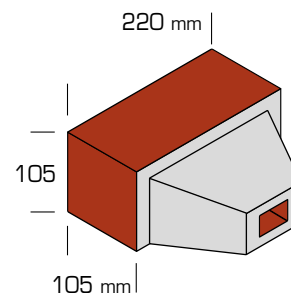

Croma SP **248**





Rivestimenti Naturali

Fortis

## Mattoni per pavimentazione

### **Una passeggiata nell'eleganza.**

Superfici ad alte prestazioni, specifiche per le pavimentazioni esterne e l'arredo urbano, che aggiungono originalità anche agli interni. Con questi mattoni, terrazzi, giardini e strade di accesso possono essere coordinati con le facciate esterne. Ideali anche per le zone pedonali dei centri storici. Resistenti e inalterabili nel tempo, nascono dall'unione di altissime garanzie in fatto di robustezza e funzionalità. La cottura a temperature elevate li rende resistenti nel tempo ai carichi meccanici, ai sali, le basi e gli acidi. Non assorbono acqua, i colori sono resistenti agli agenti atmosferici e non sbiadiscono al sole.

## *Paving bricks*

### ***A walk in elegant surroundings.***

*High performance surfaces intended specifically for outdoor pavings and city streets, they also add originality indoors. Terraces, gardens and driveways can perfectly match the outer façades of the buildings thanks to these bricks. They are also ideal for pedestrian areas in historical city centers. They are resistant and don't change in time. They represent the perfect combination of two guarantees: solidity and functionality. As they are fired at high temperatures, they can bear heavy loads, and are resistant to salts, bases and acids. They do not absorb water and their colors resist all kinds of weather conditions and do not fade in the sun.*



### **Garanzia 10 anni**

- Colori stabilizzati che non possono sbiadire al sole.
- Bassissimo coefficiente di assorbimento d'acqua.
- Resistenti al gelo e a tutti gli agenti atmosferici.
- Resistenti sia all'usura sia ai carichi meccanici.
- Resistenti agli agenti chimici acidi e basici.

### **Warranty 10 years**

- *Stable colors that do not fade in the sun.*
- *Very low coefficient for water absorption.*
- *Resistant to frost and all kinds of weather conditions.*
- *Resistant both to wear and to heavy loads.*
- *Resistant to acid and base chemicals.*

Cartella colori • *Colour range*



**Fortis 717**

pag. 294



**Fortis 727**

pag. 296



**Fortis 747**

pag. 298



**Fortis 767**

pag. 300



**Fortis 777**

pag. 302

# Fortis 717



Dimensioni • Size	200 x 50 x 80 mm
Peso • Weight	1,57 Kg
Pezzi per bancale • Pieces x pallet	960
Pezzi/m <sup>2</sup> posa di piatto • Pieces x sqm flat laying	62
Pezzi/m <sup>2</sup> posa a spina di pesce • Pieces x sqm herringbone laying	100





# Fortis 727



Dimensioni • Size	200 x 50 x 80 mm
Peso • Weight	1,57 Kg
Pezzi per bancale • Pieces x pallet	960
Pezzi/m <sup>2</sup> posa di piatto • Pieces x sqm flat laying	62
Pezzi/m <sup>2</sup> posa a spina di pesce • Pieces x sqm herringbone laying	100



# Fortis 747

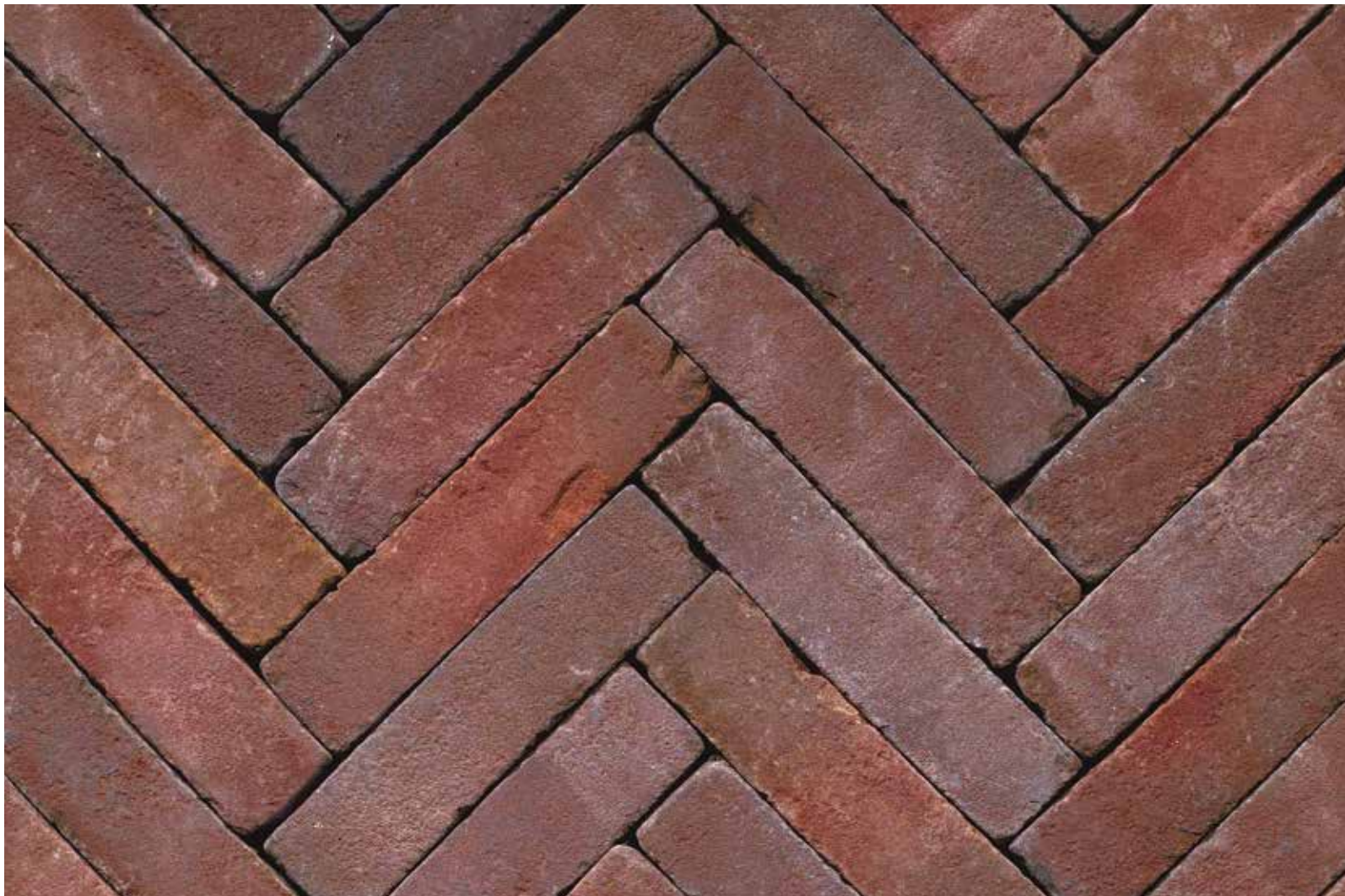

Dimensioni • Size	200 x 50 x 80 mm
Peso • Weight	1,57 Kg
Pezzi per bancale • Pieces x pallet	960
Pezzi/m <sup>2</sup> posa di piatto • Pieces x sqm flat laying	62
Pezzi/m <sup>2</sup> posa a spina di pesce • Pieces x sqm herringbone laying	100



# Fortis 767

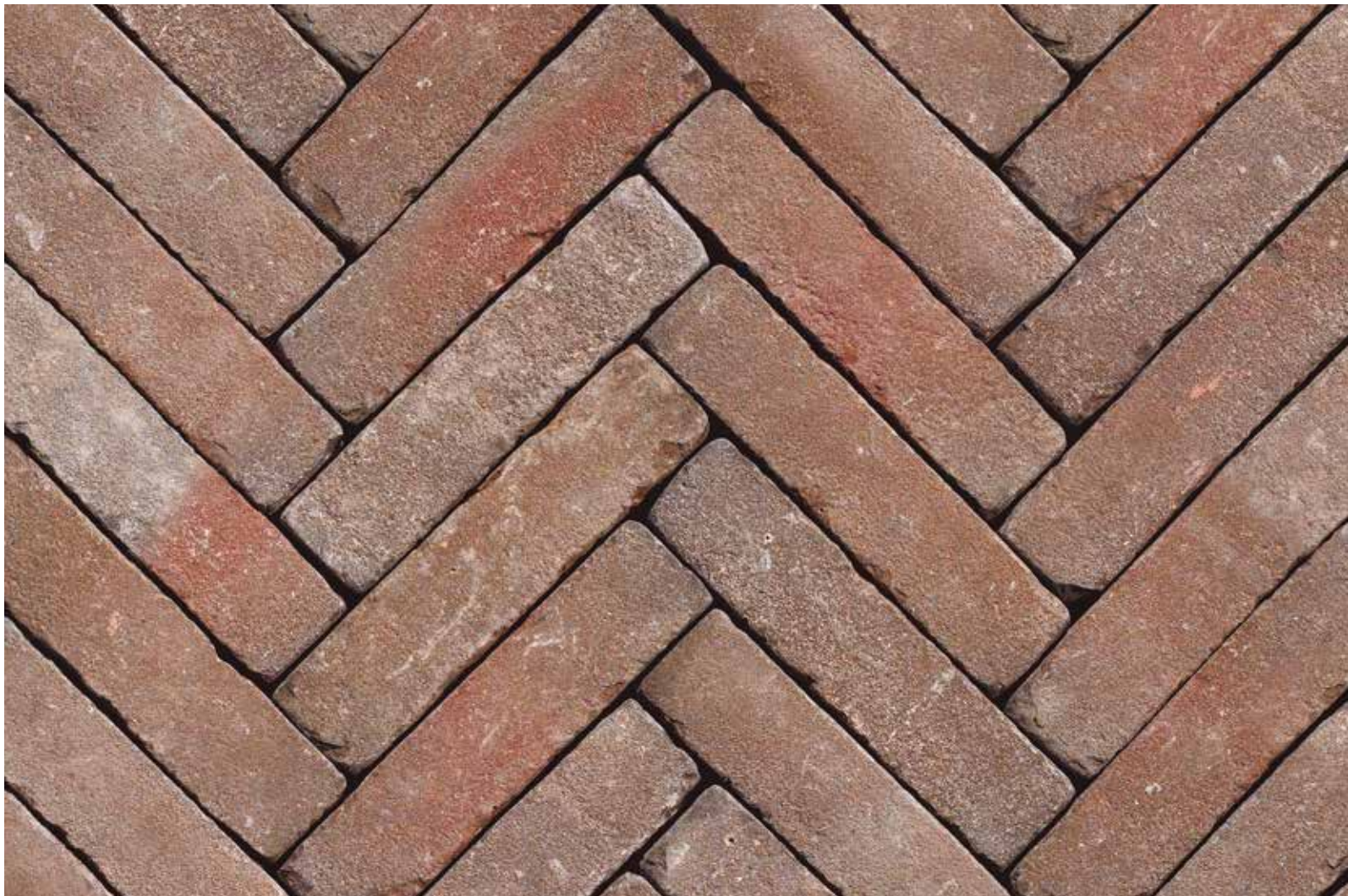

Dimensioni • Size	200 x 50 x 80 mm
Peso • Weight	1,57 Kg
Pezzi per bancale • Pieces x pallet	960
Pezzi/m <sup>2</sup> posa di piatto • Pieces x sqm flat laying	62
Pezzi/m <sup>2</sup> posa a spina di pesce • Pieces x sqm herringbone laying	100



# Fortis 777



Dimensioni • Size	200 x 50 x 80 mm
Peso • Weight	1,57 Kg
Pezzi per bancale • Pieces x pallet	960
Pezzi/m <sup>2</sup> posa di piatto • Pieces x sqm flat laying	62
Pezzi/m <sup>2</sup> posa a spina di pesce • Pieces x sqm herringbone laying	100



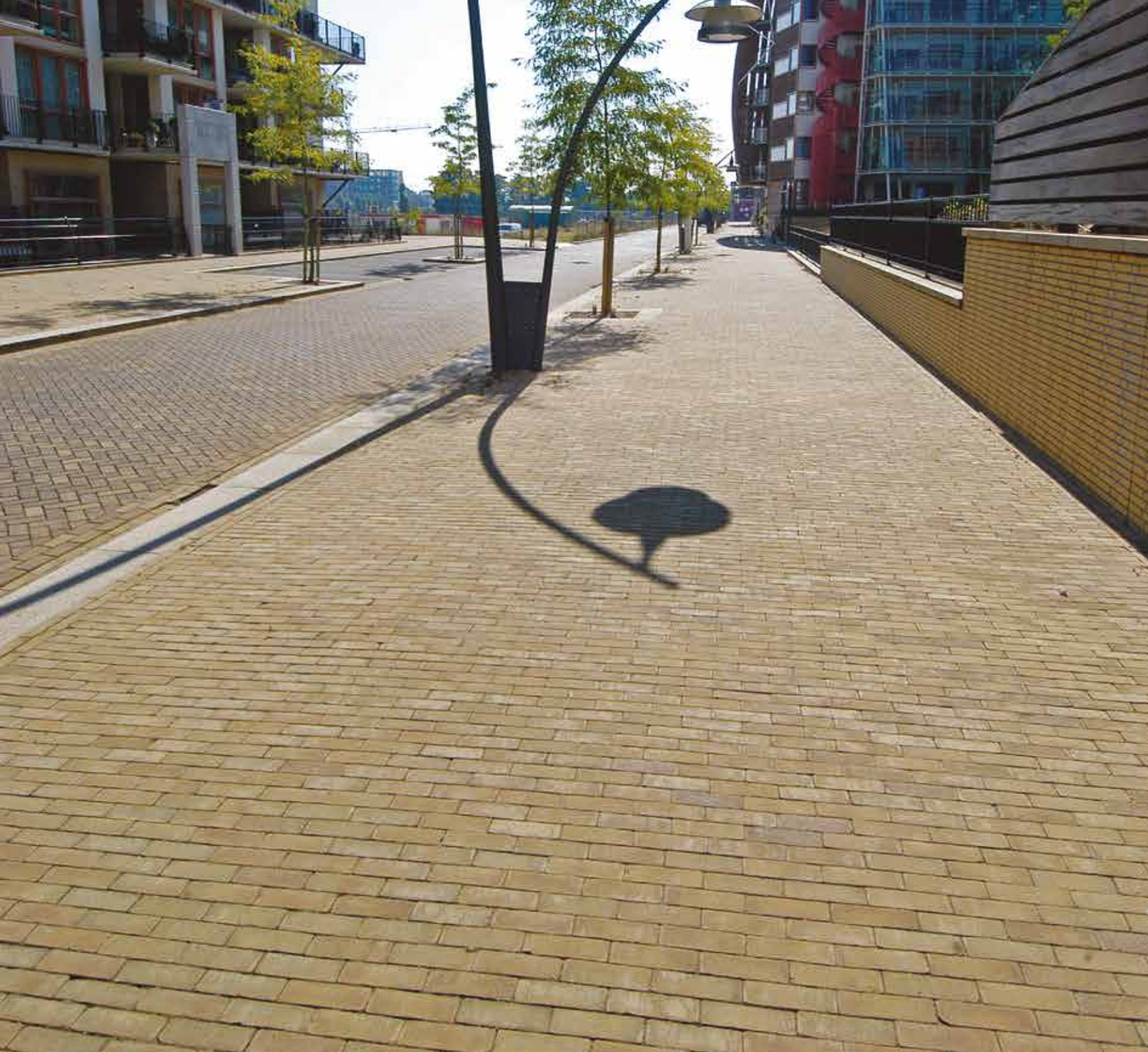





Rivestimenti Naturali

Cotto

## Antico Cotto fatto a mano

### **Cotto con sapienza, cotto ad arte.**

Un impasto di tradizione e bellezza, un rivestimento che diventa un pezzo d'arredo: è il cotto antico fatto a mano, il risultato di una sapiente lavorazione artigianale che trasforma la terra in un capolavoro da ammirare per sempre. Con le sue sfumature che esprimono il calore della terra naturale, è un materiale perfetto nelle ambientazioni storiche e rustiche, si rivela una scelta originale anche inserito in un'atmosfera contemporanea.

## *Antique handmade terracotta*

### ***Fired with age-old craftsmanship.***

*The perfect combination of tradition and beauty, this material becomes part of your home furnishing. The antique handmade terracotta is the result of a wise old craft that transforms earth into a masterpiece that can be admired forever. Thanks to its shades of colour that radiate the natural warmth of the earth, this material is perfect for historical and rustic areas. It proves to be an original choice also in a modern atmosphere.*

# Cotto

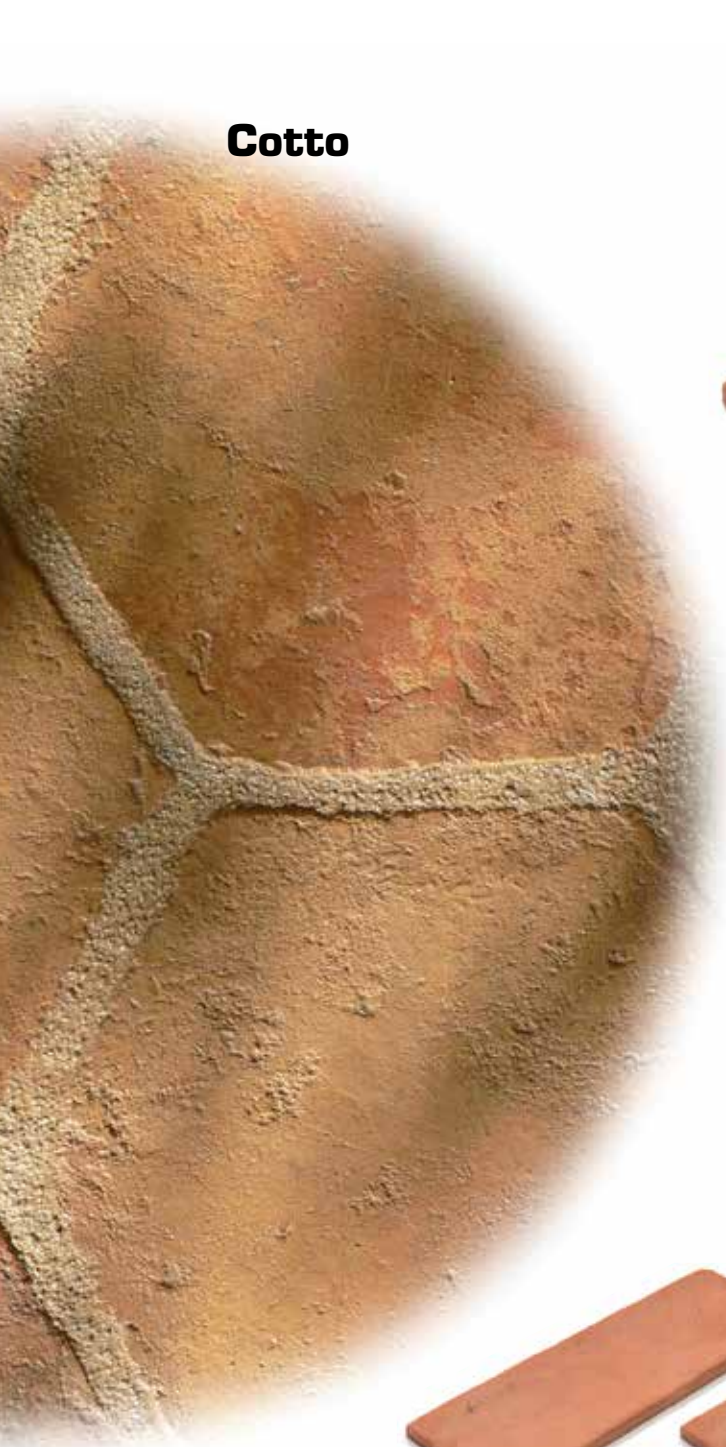

## Formati per pavimenti *Shapes for pavings*



### **Rettangolare** *Rectangular*

12x25x2,5 cm  
15x30x2,5 cm  
18x36x2,5 cm  
25x50x3 cm



### **Quadrato** *Square*

10x10x2,5 cm  
15x15x2,5 cm  
20x20x2,5 cm  
25x25x2,5 cm  
30x30x2,5 cm



### **Esagonale** *Hexagonal*

lato 14x2,5 cm



### **Ottagonale** *Octagonal*

lato 10x2,5 cm

## Formati per sottotetto *Sizes for ceiling tiles*



### **Rettangolare** *Rectangular*

12x25x2,5 cm  
15x30x2,5 cm  
18x36x2,5 cm  
25x50x3 cm







Cotto







# Cotto





Cotto



Tavelle sottotetto / *Clay ceiling tiles*





Pratico rotolo di altezza 80 cm  
per 15 metri di lunghezza.

*Practical roll 80 cm high  
and 15 metres long.*

# DrySystem



Conforms to ASTM E84  
Class A / Class 1 Fire Rating

**DrySystem** è un sistema di posa per garantire una parete sempre asciutta e ventilata, adatto per qualsiasi tipo di rivestimento, muratura o intonaco. La fornitura di DrySystem comprende quattro elementi:

- **Dryvent**
- **ZincoRete 2,5**
- **Tasselli di fissaggio**
- **Soffio**

**DrySystem** è ideale sia nei nuovi progetti costruttivi che nelle ristrutturazioni. Particolarmente indicato per rivestimenti posati a colla tipo pietra naturale o ricostruita, listelli in cotto, klinker, ceramica, murature in pietra in massello o mattoni faccia a vista oppure intonaco.

Si applica su qualsiasi tipo di supporto, laterizio, blocchi in cemento, cemento armato, legno ecc.

Perfetto nel rivestimento di muri contro terra in cemento armato dove si prevede o si suppone il sopraggiungere di umidità o acqua dal terreno.

**DrySystem** crea una protezione al rivestimento evitando spiacevoli inconvenienti quali formazioni di muffe, efflorescenze saline o il distacco dei prodotti.

Nel rivestimento di muri perimetrali di civili abitazioni dove è necessario prevedere la traspirazione delle murature, **DrySystem** permette l'evacuazione della condensa che si forma all'interno dell'abitazione.

Nel ripristino di vecchie murature dove l'umidità ha sgretolato l'intonaco o deteriorato il rivestimento.

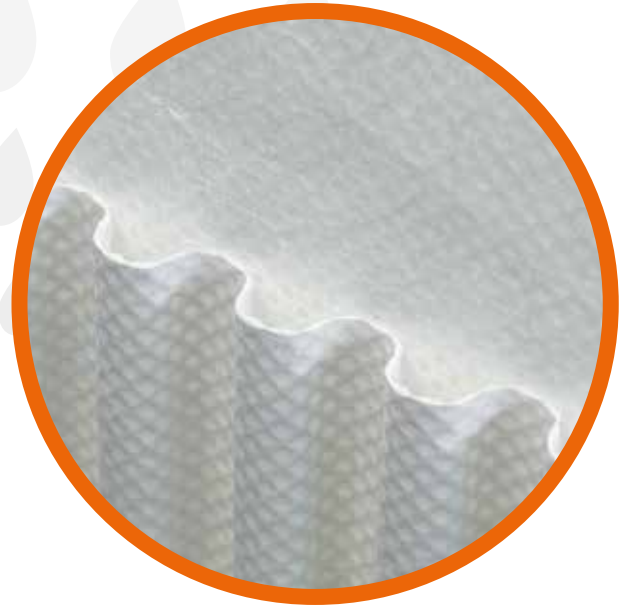

**DrySystem** is an installation system to ensure that the wall is always dry and ventilated; it can be used for all kinds of facings, wall or plaster.

There are four parts in the DrySystem package:

- **Dryvent**
- **ZincoRete 2,5**
- **Expansion fixings**
- **Soffio**

**DrySystem** is ideal both for new building projects and for renovations.

Particularly suitable for facings laid with glue, such as natural or manufactured stone, terracotta brick-slips, clinker, ceramic, block stone walls, facing bricks and plaster. It can be applied to all kinds of supports, brickwork, cement blocks, reinforced concrete, wood, etc.

Perfect for the covering of reinforced concrete walls contiguous to earth where it is likely or you suppose that humidity or water from the ground could reach the wall. **DrySystem** creates a protection for the facing by avoiding problems, such as the formations of mould, surfacing saline bloomings or the detachment of products.

In facing houses' external walls, where it's necessary to foresee their tranpiration, **DrySystem** allows the outgoing of the condensation that forms inside the house. **DrySystem** can be used to repair old walls where humidity has made the plaster crumble or where the facing has deteriorated.

# DrySystem

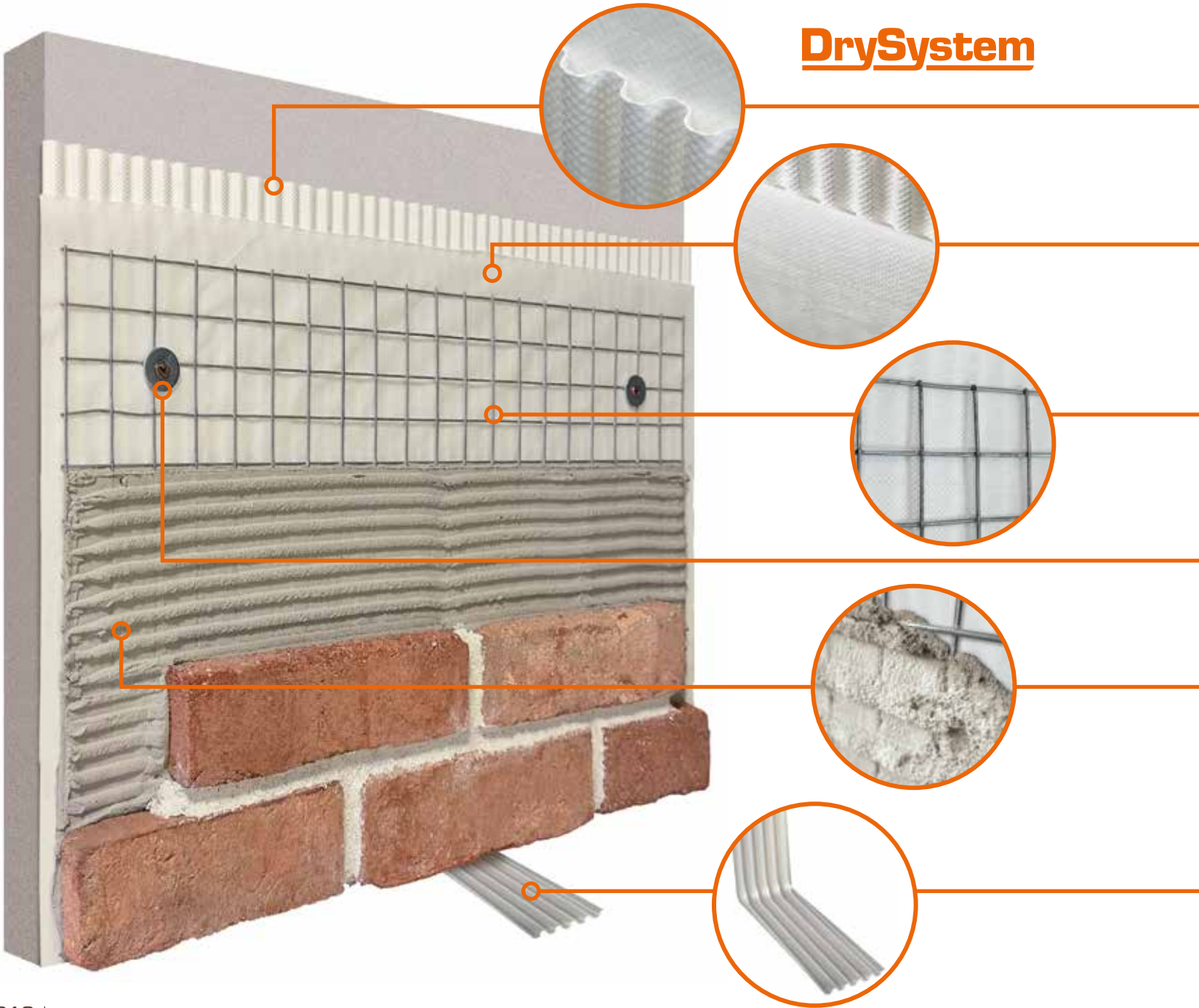



**Dryvent:** prodotto in materiale plastico riciclato, a profilo grecato passo 10 mm, con microfessure per consentire la ventilazione orizzontale e verticale. Preaccoppiato con una membrana in poliestere traspirante ma idrorepellente. È leggero e facilmente curvabile per qualsiasi tipo di supporto.

Membrana in poliestere idrorepellente.

### **ZincoRete 2,5:**

è il supporto per qualsiasi tipo di rivestimento e intonaco, è in ferro zincato, fornita in fogli piani da mm 1000 x 2000.

### **Tasselli di fissaggio:**

sono l'ancoraggio e il sostegno di tutta la parete.

### **Colla B&B:**

rinzaffo a copertura della rete per preparare l'incollaggio del rivestimento.

**Soffio:** elemento ad "elle" realizzato sempre in plastica riciclata, dal profilo grecato come il **Dryvent**, si posiziona dietro allo stesso con funzione di alimentatore della circolazione dell'aria e funzione di drenaggio dell'umidità e acqua residua.

**Dryvent:** made from 10 mm undulated recycled plastic, with narrow slits for horizontal and vertical ventilation. Pre-coupled with a breathable but water-repellent polyester membrane. Light and easy to bend for all kinds of support.

Water-repellent polyester membrane.

### **ZincoRete 2,5:**

a support grid for all kinds of facing and plaster. It is made of galvanized iron and comes in 1000 x 2000 mm flat sheets.

### **Expansion fixings:**

they are the anchor and the support of the entire wall.

### **B&B glue:**

rough coat that covers the grid before the facing is glued on.

**Soffio:** "L" shaped wall bracket that is also made from undulated recycled plastic like **Dryvent**. It is placed behind **Dryvent** to improve air circulation and to allow humidity and residual water to drain out.

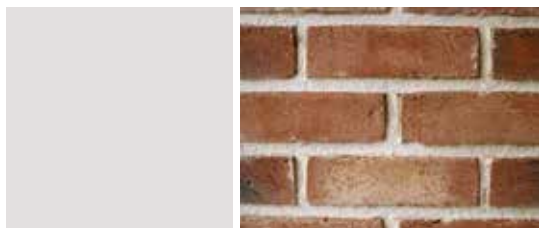

GRIGIO CHIARO cod. 11 / *PALE GREY code 11*

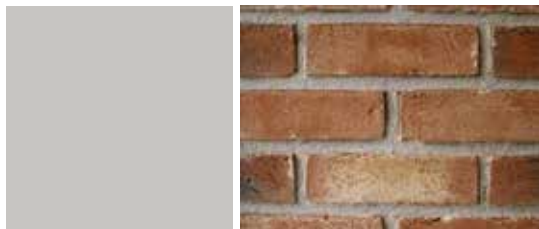

GRIGIO MEDIO cod. 99 / *MEDIUM GREY code 99*



GRIGIO SCURO cod. 66 / *DARK GREY code 66*

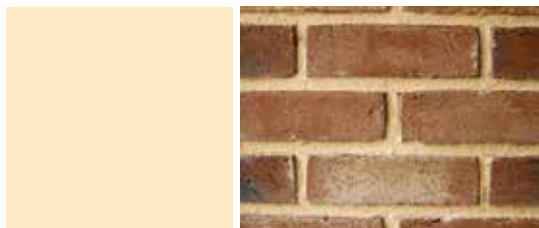

GIALLO OCRA cod. 33 / *OCHRE YELLOW code 33*

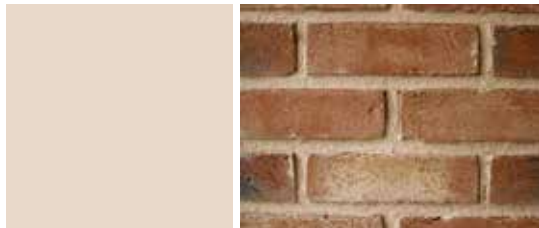

FANGO cod. 88 / *MUD code 88*

# Stucco

## Stucco



### **Sacca riempifuga B&B**

Per una perfetta applicazione utilizzare l'esclusiva sacca riempifuga B&B. cod. 46

### ***B&B joint filler bag***

*We recommend using the exclusive B&B joint filler bag, Code 46, for a perfect application.*



## Stucco e Colla speciale

### *Stucco and Special glue*

#### **Stucco B&B**

Inefflorescente certificato, appositamente formulato per i rivestimenti B&B, è disponibile in 5 colorazioni.

La grana maggiorata, ottenuta dalla miscela di sabbie inerti, conferisce un pregevole effetto "antico". Ideale per mattoni faccia a vista, listelli, pietra naturale e ricostruita. Confezione da 25 Kg.

#### **Colla speciale B&B**

Creata appositamente per B&B, ideale per il fissaggio di listelli, pietra naturale e ricostruita.

Confezione da 25 Kg.

Colla B&B cod. 91

#### ***B&B Stucco***

*Certified for not being blooming, it is specially formulated for B&B facings and it is available in 5 colors.*

*The increased grain size, obtained by mixing inert sands, gives it a valuable "antique" effect. Ideal for facing bricks, brick-slips, natural and manufactured stones.*

*25 Kg bag.*

#### ***B&B Special glue***

*Made especially for B&B, ideal for laying facing brick-slips, natural and manufactured stones.*

*25 Kg bag.*

*B&B glue code 91*

# Istruzioni di posa per mattoni e listelli

I mattoni e i listelli faccia a vista B&B sono prodotti naturali, soggetti a mutamenti delle materie prime e del processo di cottura. Questo crea differenti sfumature nei colori dei mattoni e dei listelli finiti.

Per ottenere un gradevole effetto finale è necessario seguire alcuni accorgimenti operativi:

- Prima di iniziare, accertarsi di avere in cantiere la quantità necessaria per eseguire l'intero lavoro.
- Prelevare i mattoni o i listelli da almeno 3 diversi pacchi contemporaneamente, procedendo in verticale, partendo da uno spigolo. Una corretta mescolatura consente di realizzare una muratura in cui l'irregolarità cromatica risulti uniformemente distribuita e quindi piacevole elemento di pregio estetico. (fig. B)
- Non usare mai, soprattutto nella posa dei listelli, spugne o attrezzature bagnate. Per pulirli utilizzare delicatamente una spazzola a secco.

# Laying Instructions for bricks and brick-slips

*B&B facing bricks and brick-slips are natural products and therefore the raw materials and firing process can affect them. This creates different shades in the colours of the finished bricks and brick-slips.*

*In order to achieve a pleasant result, you need to follow some practical instructions:*

- *Before you start, make sure that the correct amount of material required to complete the work is already on the site.*
- *Starting from one edge, take the bricks or brick-slips from at least 3 different packs at the same time and continue vertically. A correct mixture allows you to build a wall where the slight differences in shades of colour blend in evenly all over the wall. This gives a very pleasant result to the wall. (fig. B)*
- *Never use sponges or wet tools, especially while laying the brick-slips. Clean them by using a dry brush gently.*

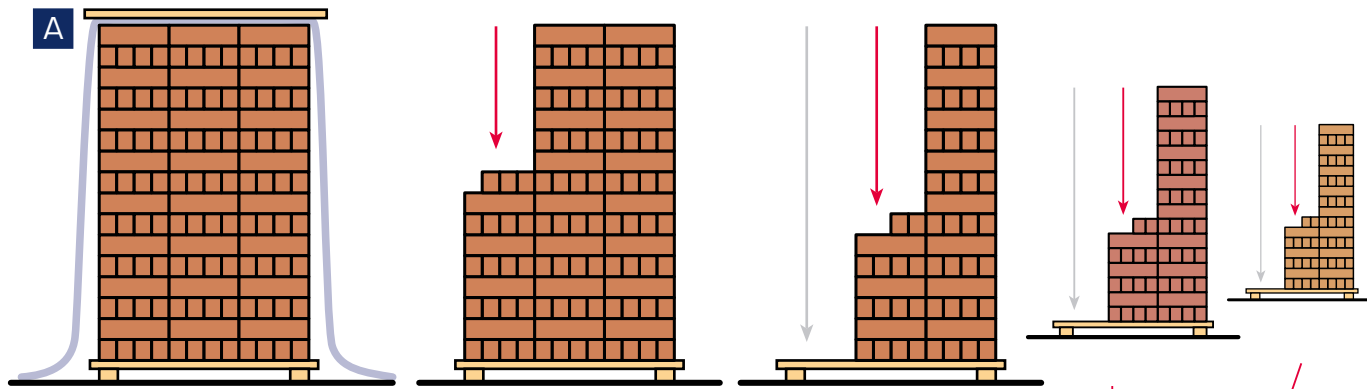

## Consigli

- Le pile di mattoni o listelli vanno sempre tenute sollevate dal terreno per evitare che si sporchino e vanno protette superiormente con teli di plastica. (fig. A)

## Advice

- *Piles of bricks and brick-slips should always be raised above the ground to prevent them from getting dirty and the top of the pile should be covered by a plastic sheet. (fig. A)*

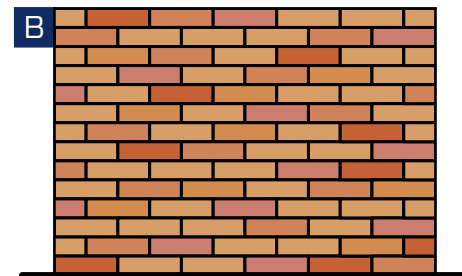

## Posa dei listelli

- 1) Rimuovere l'intonaco deteriorato e picchiare il muro.
- 2) Stendere la colla antiscivolo con una spatola dentata, per uno spessore di almeno 6 mm.
- 3) Applicare i listelli.
- 4) Riempire la fuga con stucco B&B tramite l'apposita sacca riempifuga.
- 5) Stendere e schiacciare lo stucco con l'attrezzatura necessaria.
- 6) Spazzolare per eliminare eventuali residui di stucco, senza usare acqua.

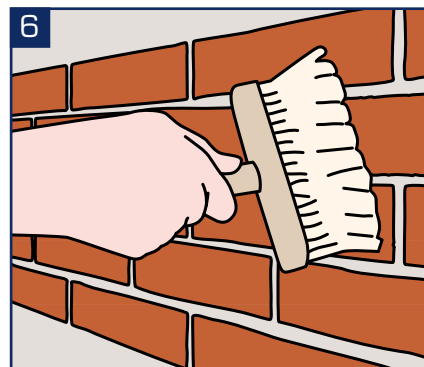
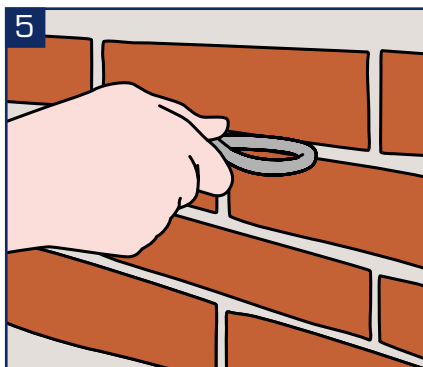
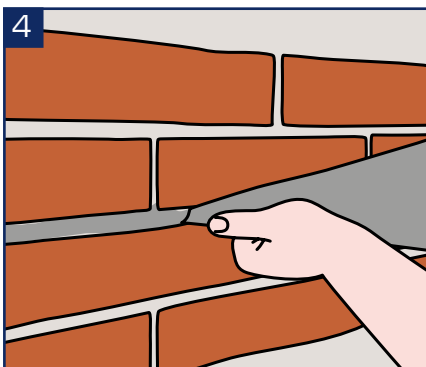
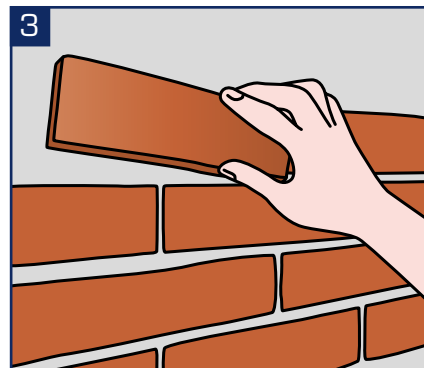
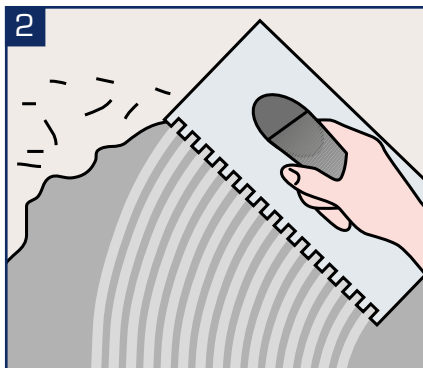
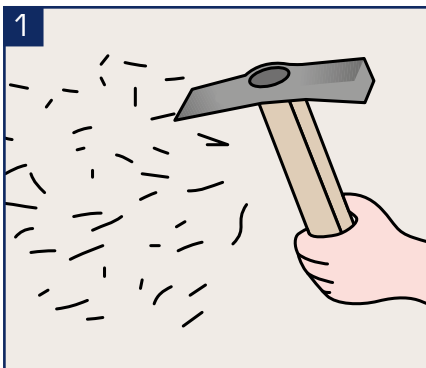

## Laying of the facing brick-slips

- 1) Remove the plaster that has deteriorated and tap the wall with a hammer.
- 2) Smooth a layer, at least 6 mm thick, of anti-slip glue with a notched trowel.
- 3) Lay the brick-slips.
- 4) Fill the joint up with B&B stucco using the special filler bag.
- 5) Smooth and press down the stucco using the correct tool.
- 6) Brush and remove any residual stucco without using any water.





B&B s.a.s. - Corso B. Telesio, 29 - 10146 Torino  
Tel. +39 011 812 61 55 - Fax +39 011 812 61 56  
info@bb-sas.it  
export@bb-sas.it

[www.bb-sas.it](http://www.bb-sas.it)